

1. Introductions

Door Station is a unit installed on the entrance of a building, which used to call a user in an apartment, and control the electronic lock opening.

This is a guide for quick installation. for more detail instructions, please refer to the DT system technical guide.

To call the user, press a button with a associated nameplate of the user; then the user will press the Unlock button on the monitor to open the door for the visitor if she/he is accepted.

A ID card can be use to open the door.(Only for DPC-D212-ID series Door Station). For detail ID card operation, please refer to DT system technical guide.

A exit button can be connect to the Door Station directly.

The Camera angle can be adjusted to coordinate the install position of the Door Station

2. Parts and functions

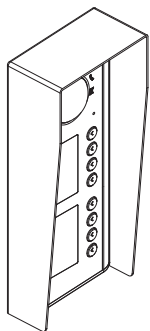
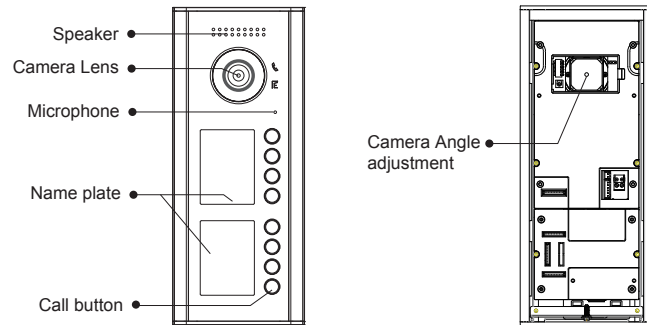

With rainy cover

3. Terminals

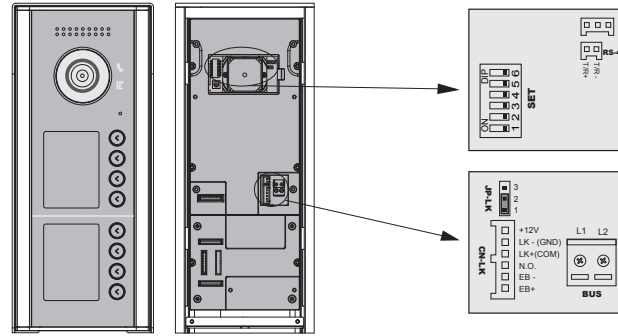

- **+12V:** 12VDC power output.
- **LK-(GND):** power ground.
- **LK+(COM):** electrical load activation relay contact common.
- **NO.:** electrical load activation relay normally open contact(refer to DT technical guide for Lock connection detail informations).
- **EB+:** Exit button.
- **EB-:** Exit buton.
- **JP-LK:** For electronic lock safety type setting(refer to Door Station Lock Connections).
- **T/R-:** USB-RS485 communication terminal negative.
- **T/R+:** USB-RS485 communication terminal positive.
- **SET:** DIP switches for system configurations.
- **Bus(L1,L2):** non-polarised bus line.

4. Connections

This example is one door station wiring, note that the lock used here is a 12Vdc 300mA power-to-unlock type. (please refer to DT technical guide for Lock connection detail informations)

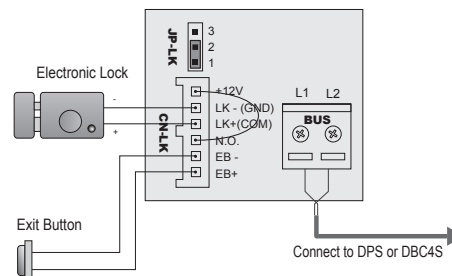

5. DIP Switches settings

Total 6 bits in the DIP switches can be configured. The switches can be modified either before or after installation.

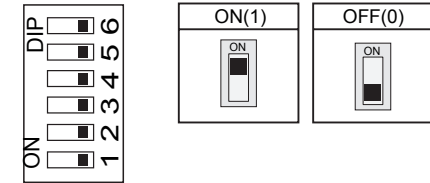

- Bit-1 and Bit 2 is for door station ID settings, when mutil door stations are installed in the system, these two bit must be set correctly, the first door station set to 00, the second one set to 01, the third one set to 10, the fourth one set to 11. If only one door station is installed, set to 00.
- Bit-3: Single line button door station or double line button door station selection. If the door station is a double line button, for examlpe, the DPC-D212 D16, set this bit to 0, set to 1 for single line button door stations.
- Bit-4: Button code selection; if use the default codes for each button of the door station, set to 0, if use the programmed codes, set to 1.(the code for each button can be program by the 2Easy+TOOL software, see the program section in this manual)
- Bit-5: Unlocking time quick selection, by default it is set to 0, for 1 second unlocking time; set to 1 for 5 seconds(by default).
- Bit-6: Set to 1,it is for door station ID settings,for examlpe,the DMR-D212-ID-S4, must be set to 1;set to 0,it is not for door station ID settings,for example,the DPC-D212-S4 must be set to 0.

6. Place Name Plate

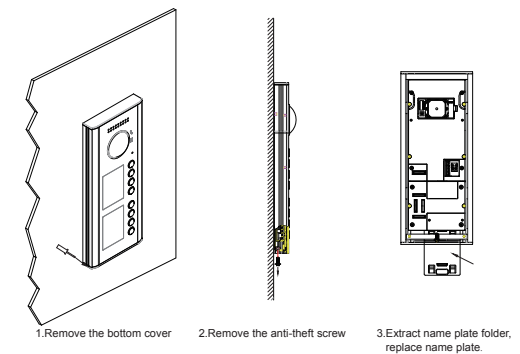

7. Door station mounting

Mounting without rainy cover

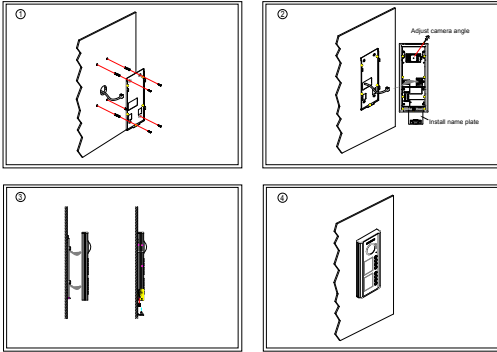

Mounting with rainy cover

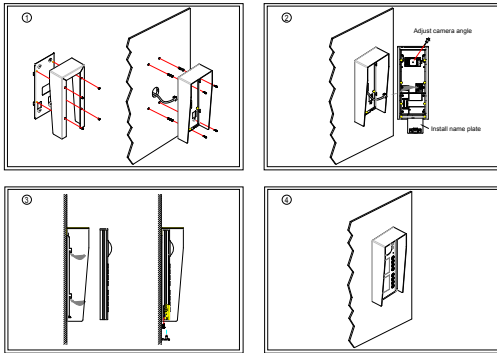

8. Installation with expanding panel

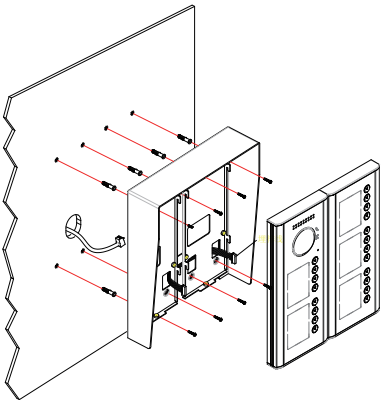

DT 2-wire System

Door Station Quick Installation Guide

