

1. Parts and Functions

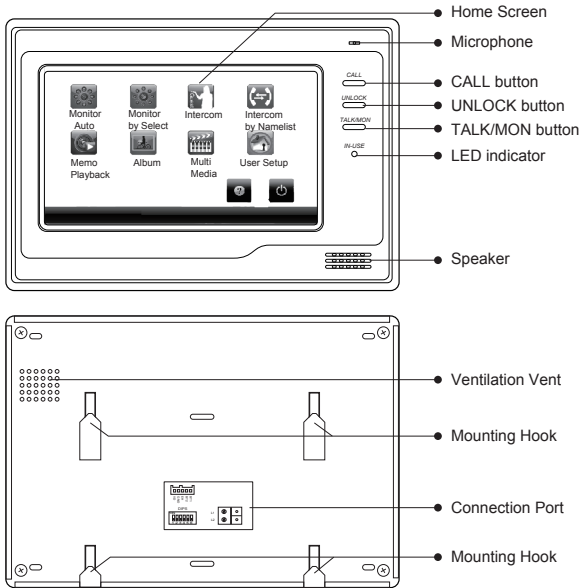

2. Monitor Mounting

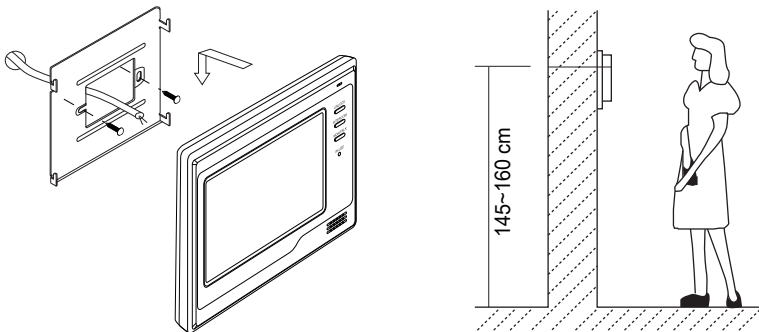





1. Use the screws to fix the Mounting Bracket on the wall.(accessories include a Bracket, two 4X25 screws (use to fasten the Mounting Bracket), 2 wire cables (use to connect with Monitor)).
2. Connect the system correctly. then hang the Monitor on the Mounting Bracket firmly.

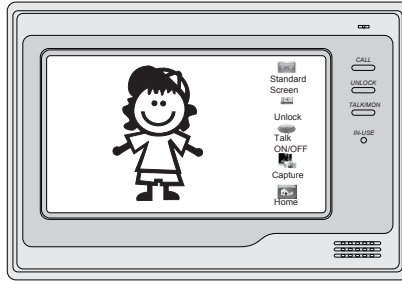

3. Talk and Unlock Operation

1. Press the Call Button on Outdoor Station, the monitor rings, at the same time, the screen displays the visitor's image.



2. Press TALK/MON Button or touch  **Talk on/off** icon, you can talk with the visitor for 90 seconds. During talking state, press the TALK/MON Button again or press  icon to end the conversation. If nobody answers the phone, the screen will be turned off automatically after 40 seconds. If the system connects two or more Monitors, pick up any Monitor, the others will be automatically shut off.
3. During the conversation, press UNLOCK Button or touch  **Unlock** icon to unlock the door.(if two locks are connected to door camera,touch  icon to release the second lock)







4. Entrance Monitoring

1. Press TALK/MON button on monitor in standby mode,or touch  **Monitor Auto** icon on home screen. the screen will display the view of the Outdoor Station. During monitoring, touch  **Select Camera** icon to get into the camera switching mode, (or touch  icon on home screen), if multi Door Stations are installed, you can press the camera 1/2/3/4 to monitor the Door Station or CCTV camera you want.





5. Intercom Function

* Intercom by Namelist

- * User in one apartment can call other apartments in the system. Touch  **Intercom Call** item on home screen page ,and then touch  **Intercom by Namelist** icon (the namelist will be created automatically by the system). or direct touch  **Intercom by Namelist** icon on home screen.Select a name on the screen then touch  **Dial Number** icon to call.Press  /  icon to enter last/next name list page. Note:1. Press "CALL" button again to redial. 2. Touch "  " icon to cancel the call.



* Intercom by Code

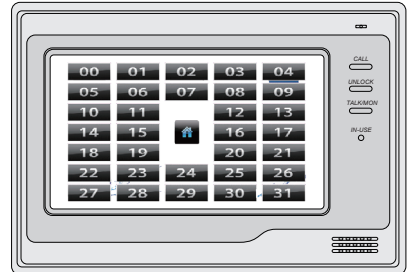

- * Touch  **Intercom** item on home screen page ,and then touch  **Selective Intercom** icon to enter intercom code page,total 32 codes will be seen on screen,you can touch each one of them to call the user.



- * **Inner Call:** If multi Monitors are installed in one user, select and press the Inner Call item, the other Monitors will ring at the same time, whichever Monitor answers the call, conversation is started,and the other monitors will stop ringing at the same time.
- * **Direct Call Guard Unit:** A Monitor can be assigned as Guard Unit Monitor; when the Guard Unit Monitor answers the call, conversation with the guard person is started..

6. Ring Setting





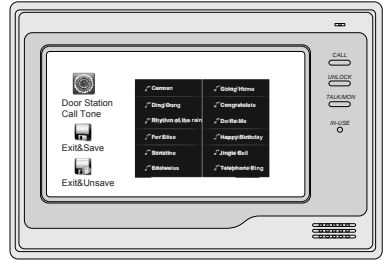

6.1 Ring Tone

12 pieces ring tones can be selected. When the Monitor is in standby, press anywhere two times on the screen, home screen will be showed.and then touch  **User Setup** icon to enter call tone setting screen,touch Door station call tone/intercom call tone/door bell call tone,12 pieces ring tones will be displayed ,you can choose a ring tone which you want,and then touch  icon to save and exit,or touch  icon to unsave and exit.



6.2 Ring Volume

Ring volume

You can set a ring volume for day time,6:00 AM~18:00 PM is the day time by default,press anywhere on the screen, home screen will be showed.and then touch  **User Setup** icon to enter next page,and then touch  **Ring Volume** icon to enter Ring Volume page,Touch  /  icon to decrease/increase the volume.and then touch  icon to save and exit,or touch  icon to unsave and exit.

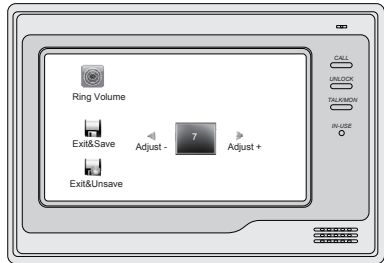

Night Ring volume

You can set a ring volume for night time,18:00 PM~6:00 AM is the night time by default,if you don't want to be disturbed at night ,you can set the volume to 0.

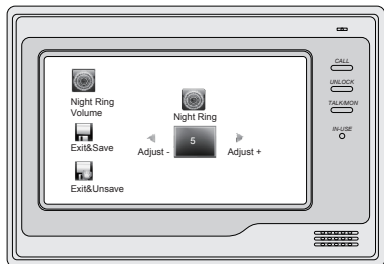

7. Monitor Time Setting

Press anywhere two times on the screen in standby mode, home screen will be showed.



Touch **Monitor by Select** icon to enter next page and then press **Monitor Time** icon to enter monitor time setting page.

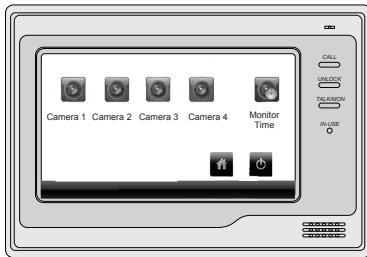

Press the digital keypad to input digitals, and press icon to change the location, and press icon to save. Settings will be performed immediately, press icon to return last page or press icon to return home screen page, or press icon to turn off the screen.

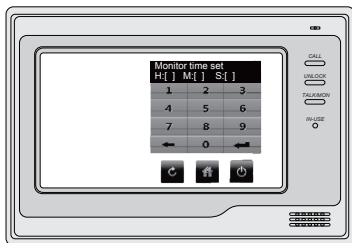

8. Screen Setting

When the Monitor is in monitoring or talking, Press **Adjust** icon to enter screen setting page.

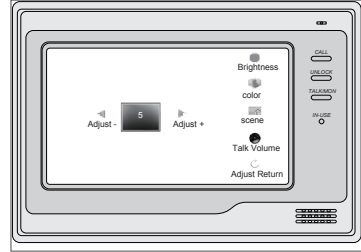

Total 4 screen setting modes: Brightness, Color, Scene, Talk Volume

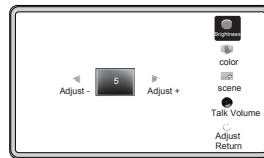

To adjust the brightness of the LCD screen.

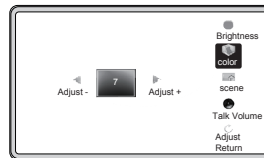

To adjust the color of the LCD screen.

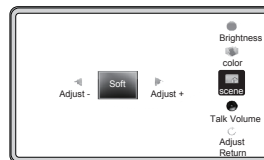

The screen can be switched to Normal, Soft, Blight and User mode.



To adjust the volume for talking.

9. Bulit-in Memory and SD Card

This Monitor has been equipped with a built-in memory (about 120 MB) together with a SD card reader. Maximum 16 GB SD card can be supported.

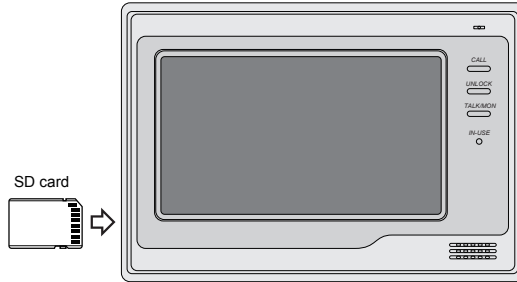

1. The monitor can play photos and pictures.
2. Photo frame function, each photo playing will last 5 seconds, More pictures in the SD card, longer time for triggering the function, 800 pictures is supported in inner memory. With 2G SD card,more than 30000 pictures can be supported.
3. Use T-views photo software tool to transform the JPG format photos took by digital camera to TVS format photos that can be viewed on Monitor.
4. The captured pictures will be saved in a folder named by date,note that the pictures recording every day will be saved in different folders which automatically generated every day
5. The captured pictures in the built-in memory can be copied to the SD card, and it can be seen on the computer.
6. The built-in memory and SD card can be formatted by the Monitor.
7. Avoid to plug in/out the SD card when the monitor is under operation.
8. Playing will be interrupted by the calling from outdoor station.





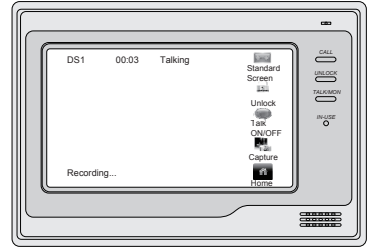

10. Picture Memo

10.1 Picture Recording

Both Auto-Recording and Manual-Recording are available. and Auto-Recording is default. If receive a Call , after 3s, the monitor will record automatically. or you can touch  icon to record the visitor's image manually.







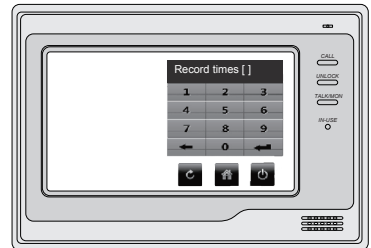



10.2 Setting

You can setup Memo Options to choose 1/4/8 pictures memo. If 4/8 was chosen, you will have 4/8 shots for each recording operation, every 1.5 seconds catch a picture. Touch two times on screen in standby mode to enter home screen, and then touch  **Multi Media** icon to enter next page, touch  **Memo Option** icon, a digital keypad will be showed on the screen, you can only set the record times for 1/4/8 by touch the digital keypad. touch  icon to save and press  icon to return last page or press  icon to return home screen page, or press  icon to turn off the screen .



10.3 Picture Playback

Touch  icon on home screen, 4 pictures will be displayed in the memo for each page. you can touch  or  to enter last or next picture memo, or touch  icon to delete all pictures. And you can zoom the picture on full screen by touch  icon , on full screen mode touch  /  icon to preview last/next picture. or you can touch  icon to delete the picture you are previewing. press  icon to return home screen page.

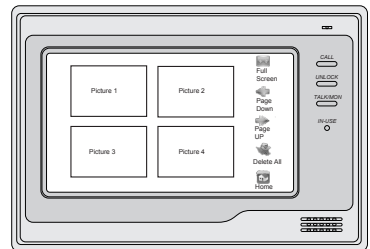







11.Photo Frame

11.1 Playing

Press anywhere two times on the screen in the standby mode, home screen will be showed.and then touch **Album**  icon to play the photos.it can be played both manually and automatically,use your fingers to slide left or right on screen to play last/next photo.

11.2 Playing time setting

Touch two times on screen in standby mode to enter home screen,and then touch  **Multi Media** icon to enter next page, touch  **Album Option** icon,a digital keypad will be showed on the screen,then you can set the palying time by touching the digital keypad to input digitals and use  icon to move location and touch  icon to save and press  icon to return last page or press  icon to return home screen page,or press  icon to turn off the screen .

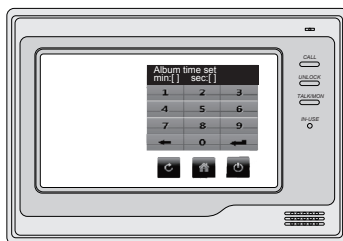

12.Specification

- Power Supply : DC 24V (supplied by Adaptor)
- Power Consumption: Standby 15mA; Working status 400mA
- Monitor Screen: 7 Inch color TFT-LCD
- Display Resolution: 800*3(RGB)*480 pixels
- Built-in Memory: 120 MB
- Monitor Dimension: 155(H)×225(W)×28(D)mm