

2 -Wire Intercom System

DPC-D244-K User's manual

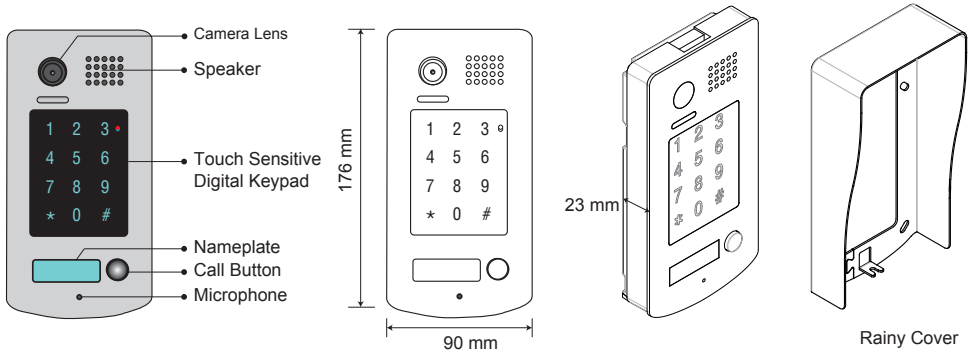

1.Parts and Functions



2.Terminal Descriptions

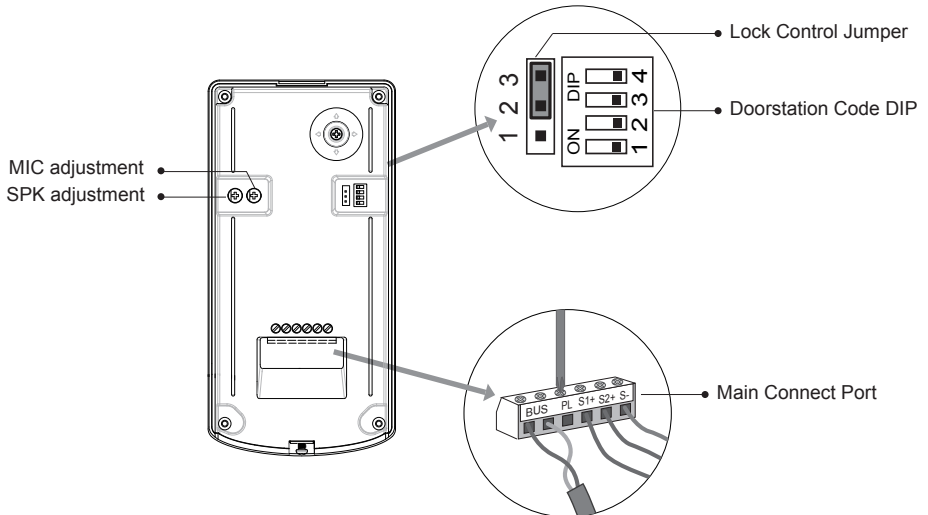

- **Lock Control Jumper:** To select the lock type: see section 5
- **Doorstation Code DIP:** Total 4 door stations can be supported, see section 6
- **MIC:** Adjust the volume of Microphone
- **SPK:** Adjust the volume of Speaker
- **Main Connect Port:** To connect the bus line and the electronic locks.
- **BUS:** Connect to the bus line, no polarity.
- **PL:** External lock power input, connect to the power positive(power +).
- **S1+, S2+:** Lock power(+) output, to connect 2 locks.
- **S-:** Lock power(-) output, connect to the power(-) input of locks(only when using the camera to power the locks, if using the external power supply for the locks, the S- will not be connected).

4. Door Station Mounting

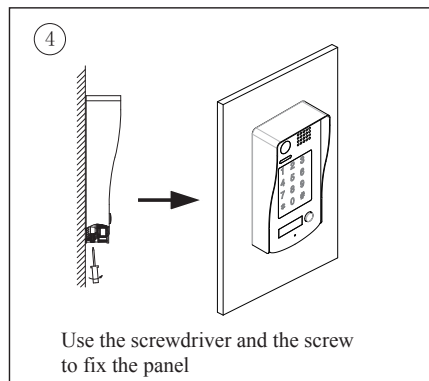
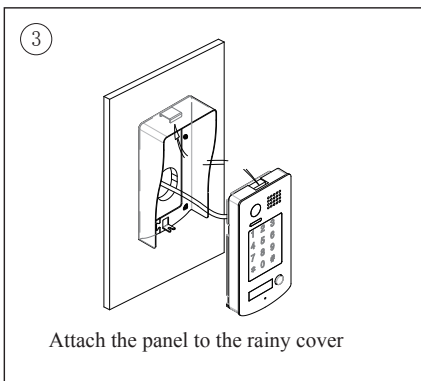
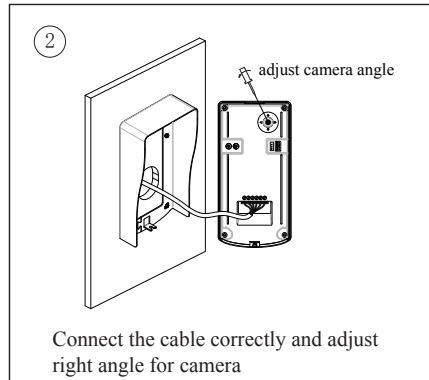
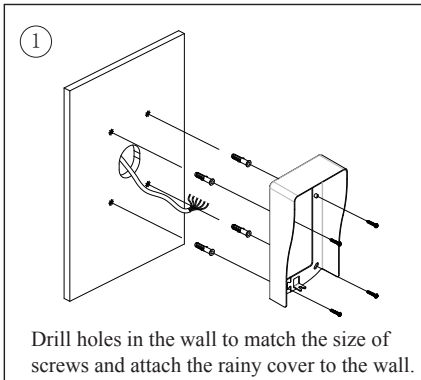

Placing Name Label

Move the plastic cover away to open the transparent name label cover, insert a name paper, then put the plastic cover back to the panel.

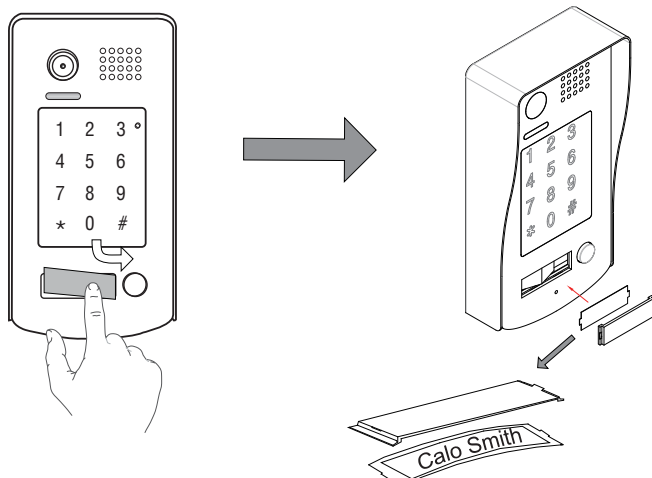

Adjusting Camera Angle

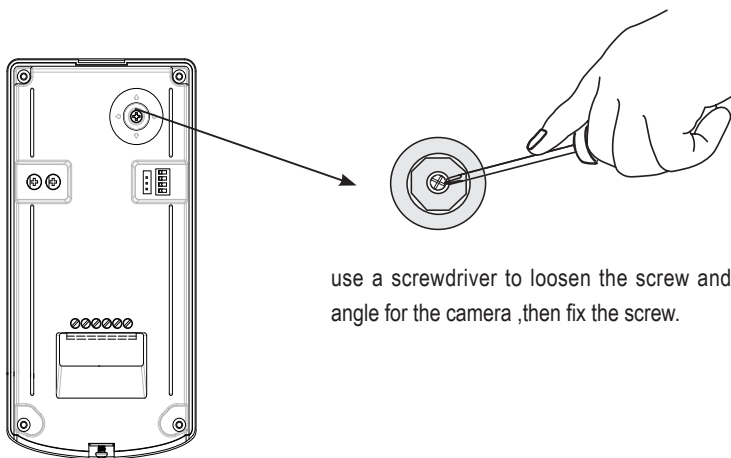

use a screwdriver to loosen the screw and adjust the angle for the camera ,then fix the screw.

5. System Wiring and Connections

Basic Connection

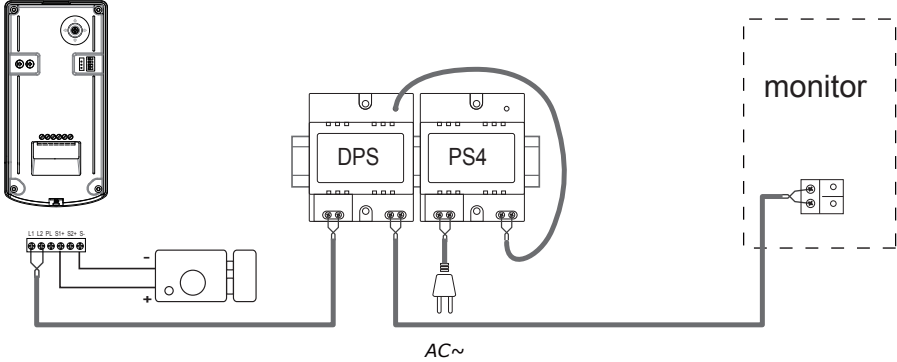

Electric Lock Connection

Door Lock Controlled with Internal Power

Note:

1. Electronic lock of Power-on-to-unlock type should be used.
2. The door lock is limited to 12V, and holding current must be less than 250mA.
3. The door lock control is not timed from Exit Button(EB).
4. The **Unlock Mode** Parameter of Monitor must be set to 0 (by default).



Jumper position in 2-3

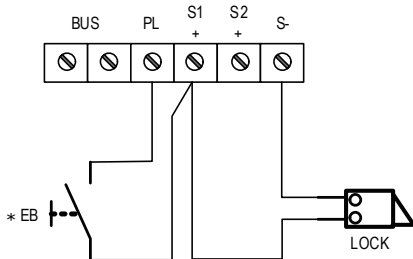

Jumper position in 2-3

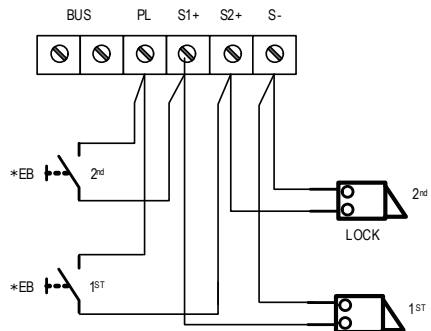

Electromagnetic Lock Connection

Door Lock Controlled with Internal Power

Note:

1. Electromagnetic lock of Power-off-to-unlock type should be used.
2. The door lock is limited to 12V, and holding current must be less than 250mA.
3. The door lock control is not timed from Exit Button(EB).
4. The **Unlock Mode** Parameter of Monitor must be set to 1 (by default).



Jumper position in 1-2



Jumper position in 1-2

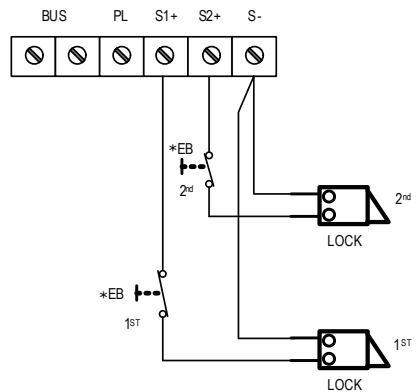
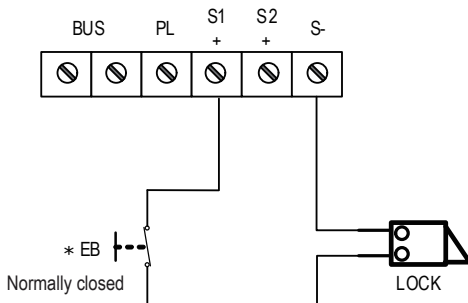

Door Lock Controlled with Dry Contact

Note:

1. The external power supply must be used according to the lock.
2. The inside relay contact is restricted to AC or DC 24V/3A.
3. The jumper must be taken off before connecting.
4. Setup the **Unlock Mode** of Monitor for different lock types.
 - Power-on-to-unlock type:Unlock Mode=0 (by default)
 - Power-off-to-unlock type:Unlock Mode=1

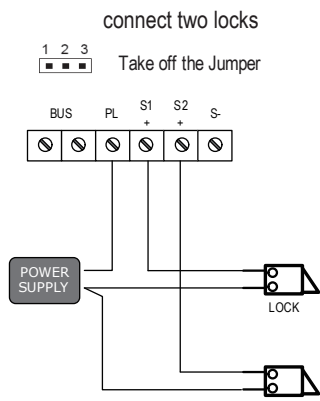
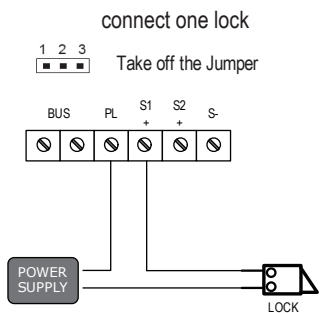

Unlock parameter setting(set in monitor)

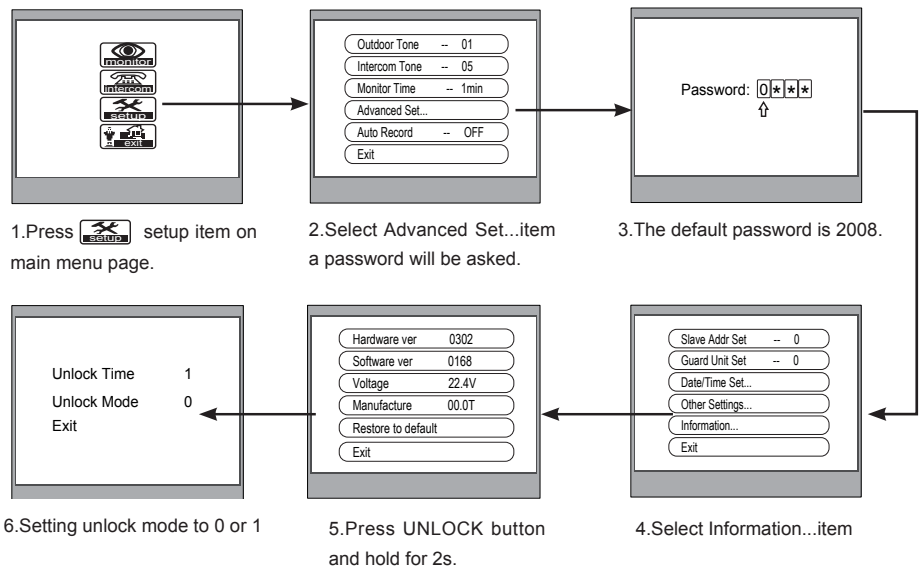

Note:

1. must connect DPC correctly before setting.
2. the parameter will be saved in DPC automatically, so you need only set on one monitor.
3. the above cutline is fit for some series monitors only

Multi Door Stations Connection

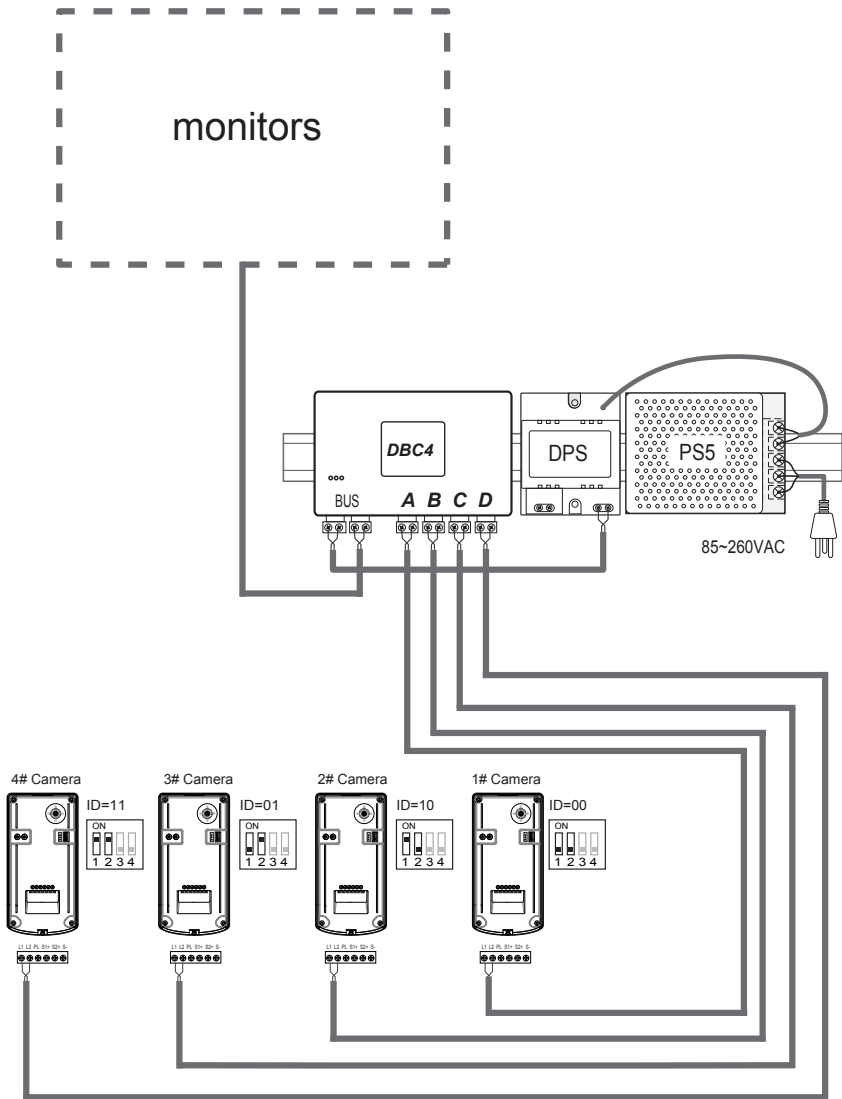

Multi Monitors Connection

Basic IN-OUT Wiring Mode

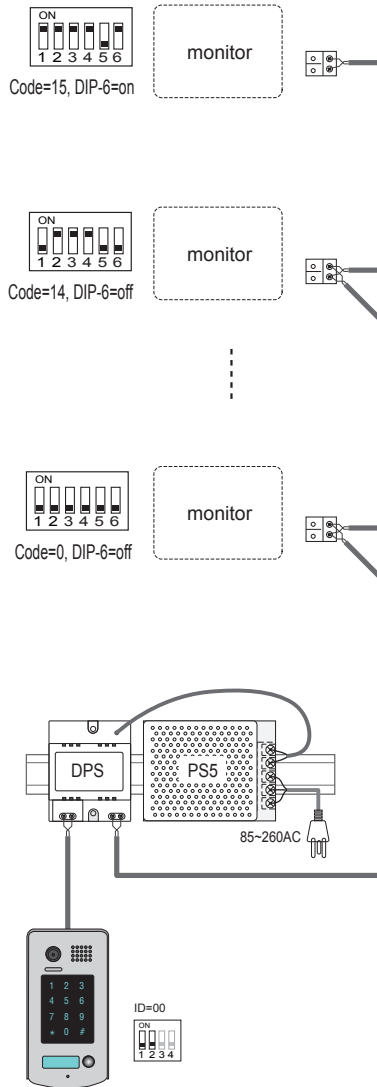

6.DIP Switches Setting

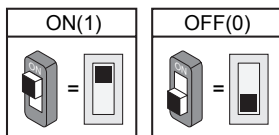

DIP Switches Settings of Door Station

Total 4 bits on the DIP switches can be configured. The switches can be modified either before or after installation.

Setting Item	Bit state	Descriptions
Bit1 and Bit2 <i>(it is used to set the ID code for door station)</i>		Default setting, ID = 0(00), set to the first Door Station.
		ID = 1(10), set to the second Door Station.
		ID = 2(01), set to the third Door Station.
		ID = 3(11), set to the fourth Door Station.
Bit3		Activate external output setting, the relay 2 terminal doesn't respond the second lock and will be closed for 60 seconds when the "Lockout" is carried out. The alarm connected to the terminal of relay 2 will be activated
		Not activate
Bit4		Reserve

















DIP Switches Settings of Monitor

There are 6 bit switches in total. The DIP switches are used to configure the User Code for each Monitor.

Bit-6 is line terminal switch, which have to be set to ON if the Monitor is in the end of the bus, otherwise set to OFF.

Bit state	Setting	Bit state	Setting
	The monitor is not at the end of the bus.		The monitor is at the end of the bus.

Bit-1 to Bit-5 are used to User Code setting.The DT596 responds to 0~15 .

Bit state	User Code	Bit state	User Code	Bit state	User Code
	Code=0		Code=6		Code=11
	Code=1		Code=7		Code=12
	Code=2		Code=8		Code=13
	Code=3		Code=9		Code=14
	Code=4		Code=10		Code=15
	Code=5				

7. Functions Setting Up

This section explains the settings of each function,please refer to the following table:

About the setting mode:

Input the master code to switch to the setting mode, and input the corresponding setting code to perform the settings for the function you want. After settings have been made, input the following setting codes to continue the setting operation. Press "*" to exit the setting mode.



- The example is set * as cancel button and # as confirm button,please refer to */# function setting for detail information.
- Forbid to slide to touch the digital keypad,it may cause mistaken key,the correct operation is using your finger to press the digital you desired.
- You should press“confirm”button after finish inputting the code number each time,otherwise,the operation will be canceled automatically in 10s.

Order	Setting items	Setting range	Default value	Setting code
1	Reset all settings	1,2,3,4	-	00
2	Setting the master code	1 ~ 12 digits Valid keys:0 ~ 9	1,2,3,4	01
3	Setting the key illumination time	10 to 99 seconds/ continually lit	10 seconds	02
4	Setting the unlock time	01 to 99 seconds	1 seconds	03
5	Setting the unlock mode	0:opened/1:closed	opened	04
6	Operation tone settings	0:on/1:off	on	05
7	Reset code settings	1,2,3,4	-	06
8	*&# function settings	0:Normal/1:Reverse	Normal	07
9	Call tone settings	0:Enable/1:Disable	Enable	08
10	Interference resistant grade settings	Valid keys:0 ~ 5	2	09
11	Reserve(<u>not used</u>)	Reserve	Reserve	10~17
12	Setting the code forTemporary1	1 ~ 12 digits Valid keys:0~9	-	18
13	Setting the code forTemporary2	1 ~ 12 digits Valid keys:0~9	-	19
14	Setting the code for user group1	1 ~ 12 digits Number of codes:40 Valid keys:0~9	-	20~59
15	Setting the code for user group2	1 ~ 12 digits Number of codes:40 Valid keys:0~9	-	60~99



Each operation is indicated by the lighting up of the LED indicators on the right section of the unit, and by the sounding of the buzzer.

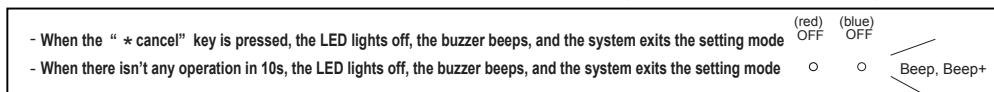
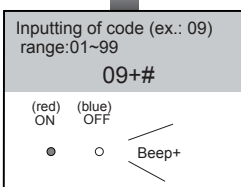
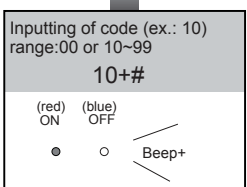
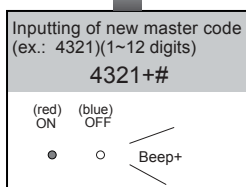
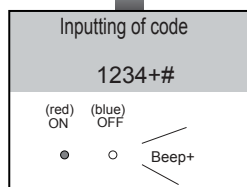
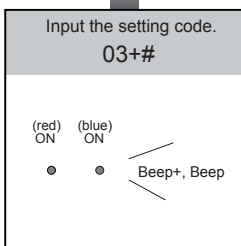
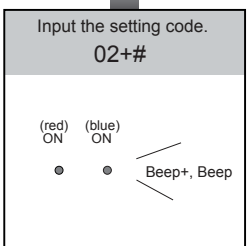
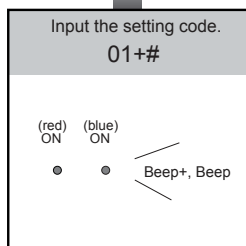
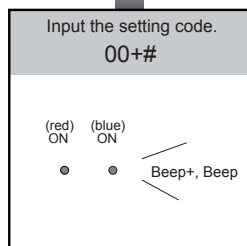
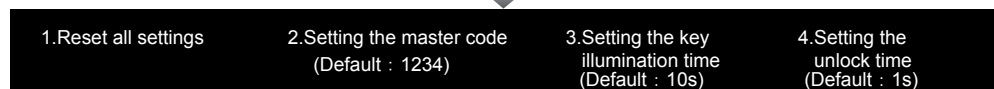

- All settings will restore to their default value.
- When power on or activate the reset all setting item, the keypad checking will carry out, during this time, the key illumination will blink and the touching operation is forbidden, after finish checking, the key illumination will stop blinking and sent out a long sound of beep

- The master code is allowed 1~12 digits, the same code cannot be set for both the user code and the master code, it is recommended that you modify the default master code.

- If the key illumination time is set to 00, the key illumination will light up all the time when power on.
- If the key illumination time is set to 10~99, the key illumination will light up for 10~99 seconds. At this mode, the key illumination lights off in standby mode, touching any digital key can illuminate, but this is the invalid digital.

- The unlock time can be set on both monitor and door station, and the valid value is the number you set last time.



5. Setting the unlock mode (Default : 0(opened)) 6. Setting operation tone (Default : ON)
7. Reset code setting 8. *&# function setting (Default : Normal)

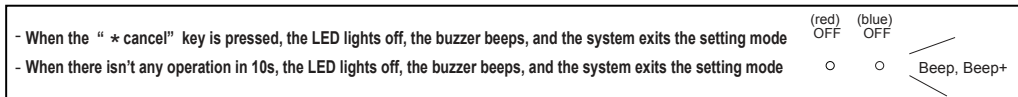
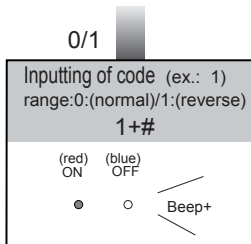
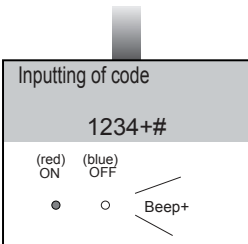
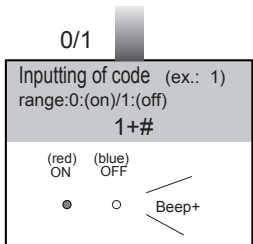
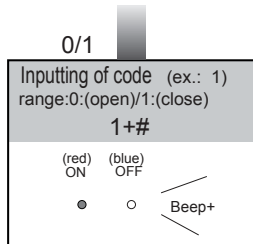
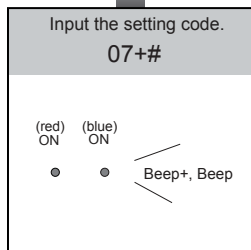
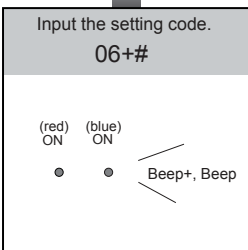
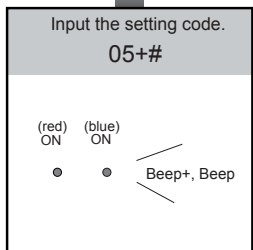
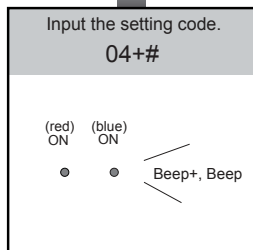

- The unlock mode can be set on both monitor and door station, and the valid value is the number you set last time.

- When the operation tone is set to 0, pressing the digital keypad will sent out a sound of beep.
 - When the operation tone is set to 1, pressing the digital keypad will blink one time.

- Cancel all the passwords except the master code.
 - Restore the master code to default value(1,2,3,4)

- When the item is set to 0, press the * button to cancel the input, and press the # button to confirm the input.
 - When the item is set to 1, press the # button to cancel the input, and press the * button to confirm the input.



9. Call tone setting (Default : enable) **10. Interference resistant grade setting (Default : 2)**

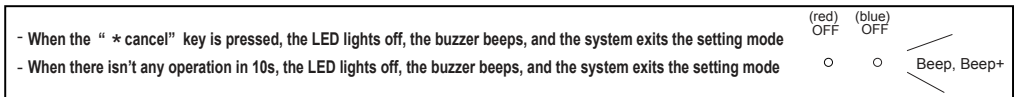
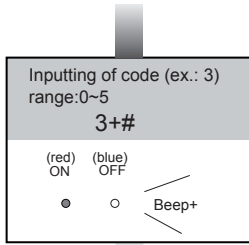
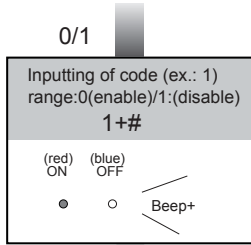
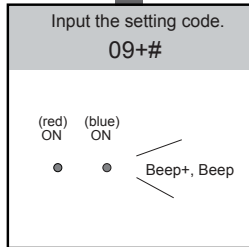
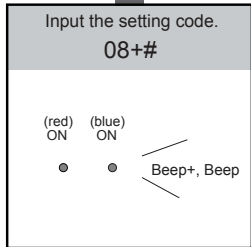

- If the item is set to 0, the unit will respond a call tone when pressing the “CALL” button.
- If the item is set to 1, the unit will have no responds when pressing the “CALL” button.

- The larger you set the interference resistant grade, the stronger it will be, but the sensitivity of the keypad will be more lower.
- The interference resistant grade setting also will activate the keypad checking.



12. Setting the code for Temporary1 13. Setting the code for Temporary2 14. Setting the code for user group1 15. Setting the code for user group2

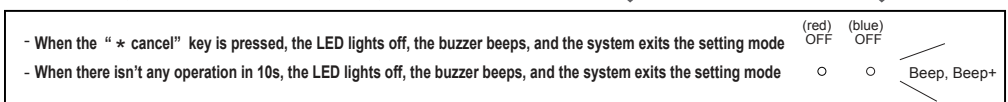
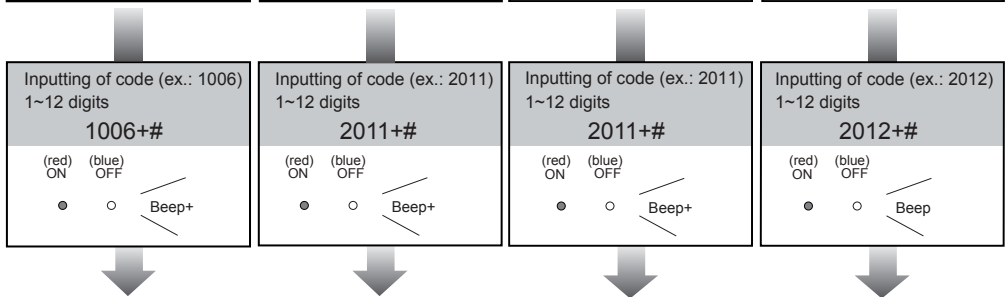
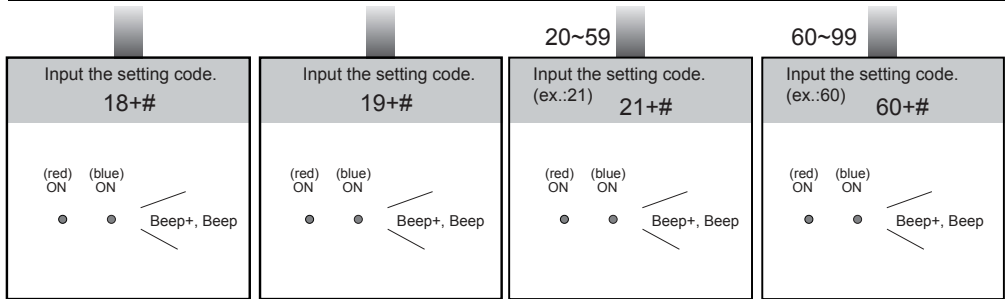

- When input the correct temporary password to release the door, the system will clear the temporary password after 60 seconds automatically. But you should know that the password is valid within 60 seconds after inputting the correct temporary password
- The temporary1 is used to release the first lock, and the temporary 2 is used to release the second lock.
- If the password length exceeds 12 digits, the system will send out the sound of “beep,beep,beep,beep”, and the digitals you input before will be cleared at the same time.
- The temporary code can not be set the same as the master code and user code.

- The user code group1 is used to release the first lock, and the user code group2 is used to release the second lock.
- The user code group1 and user code code group2 can contain 40 group passwords
- If the password length exceeds 12 digits, the system will send out the sound of “beep,beep,beep,beep”, and the digitals you input before will be cleared at the same time.
- The user code can not be set the same as the master code and temporary code.

8.Unlock Operations

Unlocking of user code

When the registered user code has been input using the keypad (1~12 digits), the LED indicator (group 1: red, group 2: blue) lights up, the buzzer sounds,and the electric door strike is unlocked.

Example:group 1
2011

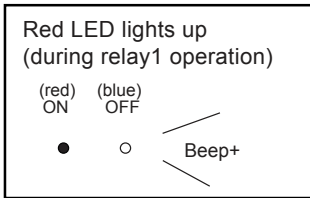

Example:group 2
2012

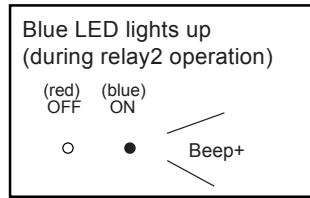

- The time interval during which the button must be pressed is approximately 10 seconds. If the time interval exceeds approximately 10 seconds, the input value will be cleared.
- If you make a mistake when inputting the user code,press the "cancel" button and input the user code again.
- When the "Lockout" function has been activated, the release function is forbidden and the input operation is disabled for 60 seconds if 10 times incorrect access codes are continuously attempted. ("Lockout" function:When "Lockout" is activated,the relay 2 doesn't respond the second lock but responds the LOCKOUT function.After continuously inputing incorrect access code 10 times,LOCKOUT output and the relay 2 will be closed for 60 seconds,the LED-relay 2 will be illuminated for 60 seconds) During this time,the buzzer will continuously sound about 8 times.
- You can activate the electric door strike by pressing the request to exit button connected to the unit. Pressing request to exit button 1 releases relay 1, and pressing request to exit button 2 releases relay 2.(The unlock function will work when the request to exit button is pushed, even while the "Lockout" function is operating.)



1. During calling,pressing "cancel" button can cancel the calling
2. If input the incorrect access code,the buzzer will sound of beep,beep,beep

9. Power Supply Instructions

Name	Discription	Usage
PS5-24V	Power supply,85~260Vac input,24Vdc/3A output,10 DIN modules	Connect with multi doorstations or multi monitors(up to 2 or above)
PS4-24V	Power supply,85~260Vac input,24Vdc/1A output,for basic kit only,4 DIN modules	Connect with one doorstation and one monitor(DT16 can be connected two)

10. Precautions

- Please clean the unit with soft cotton cloth, don't use the organic impregnant or chemical clean agent. If necessary, please use a little pure water or dilute soap water to clean the dust.
- The unit is weather resistant. However do not spray high pressure water on access control keypad directly. Excessive moisture may cause problems with the unit.
- You must use the right adaptor which is supplied by the manufacture or approved by the manufacture..
- Pay attention to the high voltage inside the products, please refer service only to a trained and qualified professional.

11. Specifications

- Lock Power supply: 12Vdc, 300mA(Internal Power)
- Power Consumption: 2W in standby, 8W in working
- NO, COM dry contact: Max. 48V dc 1.5A
- Camera angle: Max. 72°
- Number of relay circuits: 2
- Mounting: Surface mounting
- Dimension: 176(H)X90(L)X23(D)mm
- Working temperature: -10°C ~ 45°C

12.Cables Requirements

The maximum distance of the wiring is limited in the DT system. Using different cables may also affect the maximum distance which the system can reach.

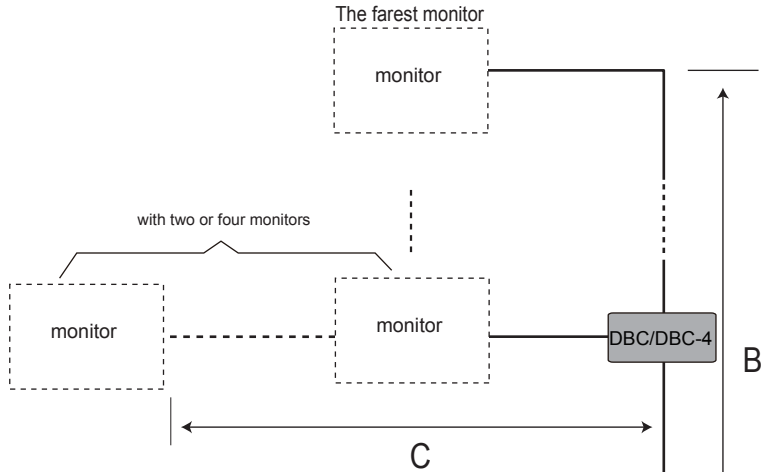

When Monitor quantity < 20

Cable Usage	A	B	C
Twisted cable 2x0.75 mm ²	60	60	30
Twisted cable 2x1 mm ²	80	80	40

When Monitor quantity > 20

Cable Usage	A	B	C
Twisted cable 2x1 mm ²	70	30	20
Twisted cable 2x1.5 mm ²	70	50	30

Note: If the monitor has been specified the distance, refer to the parameter.

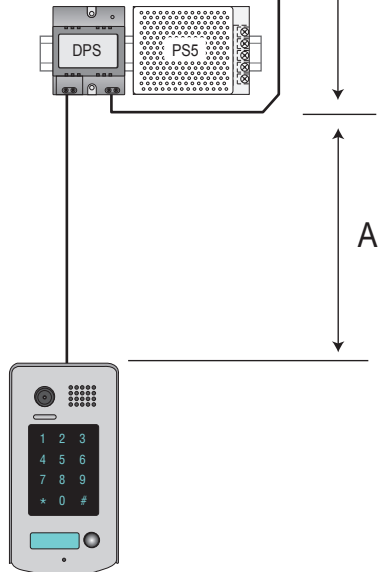



The design and specifications can be modified without notice to the user. Right to interpret and copyright of this manual are reserved.
