

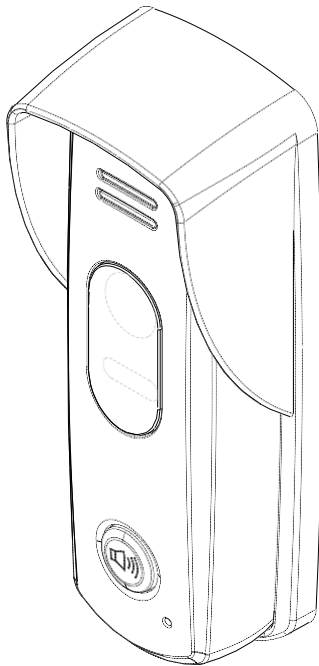

2-Wire Video Intercom System



DPC-D246A
User's manual

Parts and Function

The door station is an audio door station without camera, which is designed for 2-wire system. The front panel is made of zinc alloy for better protection against vandalism & cauterization, and the call button is also made of zinc alloy with blue backlight for auxiliary illumination, the unlock and talking LED indicator guarantee the door station working efficiently. With the rainy cover, the door station can be strongly protection against water.

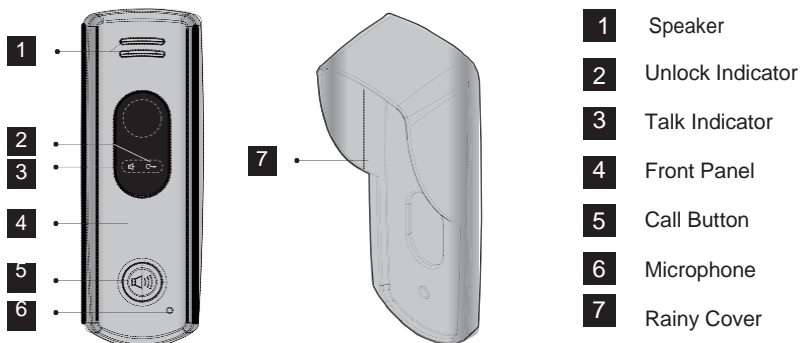

Terminal Description

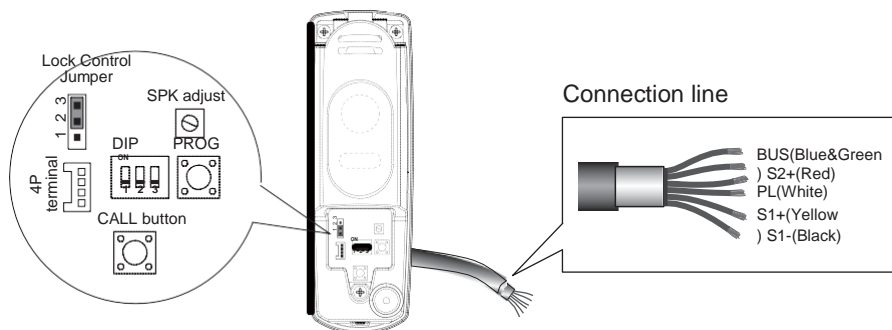

- ◆ **Lock Control Jumper:** to select the lock type. Please refer to Electric Lock Connection
- ◆ **DIP switch:** to set ID code for door station, total 4 door stations can be supported. Please refer to DIP Switch Setting.
- ◆ **SPK adjust:** to adjust the talk volume.
- ◆ **PROG button:** reserve.
- ◆ **CALL button:** press to call the user.
- ◆ **4P terminal:** to update software via specified programmer.
- ◆ **Connection line:** to connect the bus line and the electronic locks.
 BUS(Blue&Green): connect to the bus line, no polarity.
 S2+(Red): the S2+ connect with S1- to activate the relay to extend a camera of DPV-D246,

please refer to DPV-D246 user instructions in details.

PL(White): external lock power input, connect to the power positive(power +).

S1+(Yellow): lock power(+) output.

S1-(Black): lock power(-) output.

Unit Mounting

The location of outdoor station should keep away from snow,rain,and intensity light.

Accessory contents:

Accessories include a screwdriver T20, one M4X10 screw, two PA4X25 screws,three PA3x25 screws,three PM3x12 screws,and five screw stoppers Φ 6X30.

Installation steps:

Installation height for door station usually is 145~160cm.

1. Use screws to fix the back panel and rainy cover to the wall after connect the cable correctly.
2. Attach the front panel to the back panel, then use the screw to fix it.

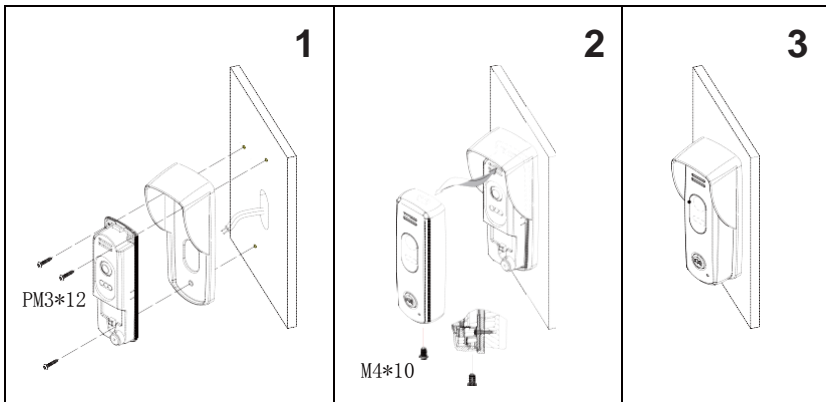

Wiring and Connection

Basic one-to-one connection

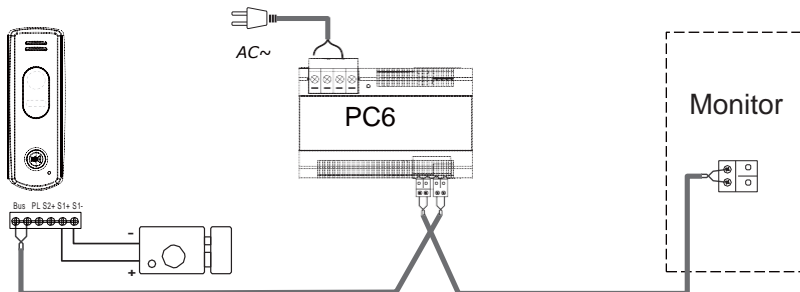

BUS(Blue&Green); S2+(Red); PL(White); S1+(Yellow); S1-(Black);

Multi Door Station Connection

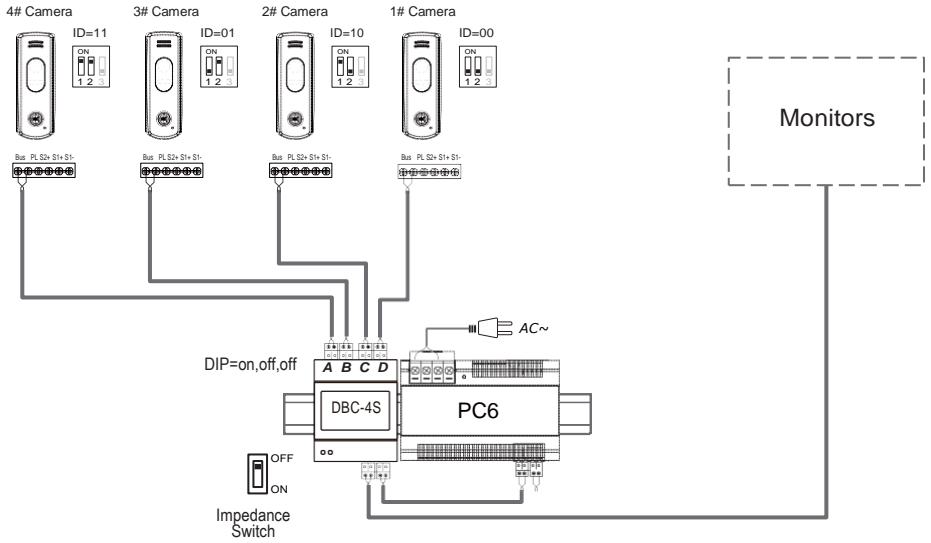

BUS(Blue&Green); S2+(Red); PL(White); S1+(Yellow); S1-(Black);

Multi Monitors Connection

Basic IN-OUT wiring mode

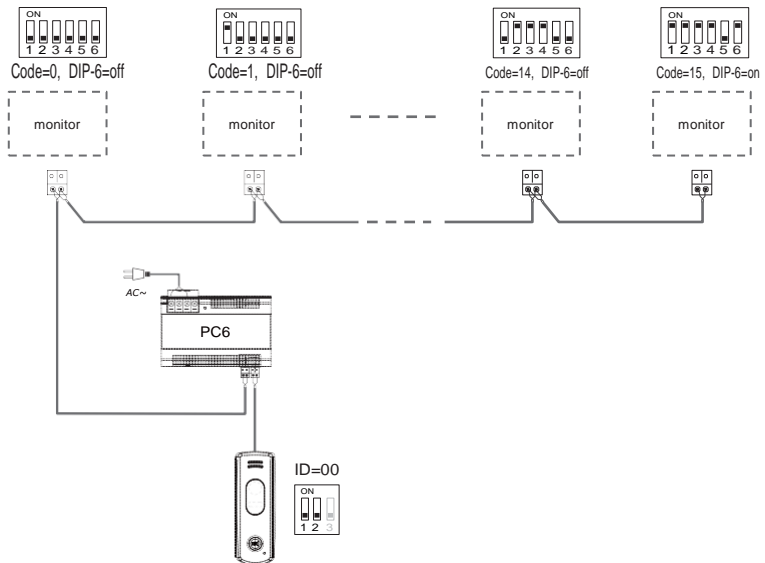

With DBC-4S Wiring Mode

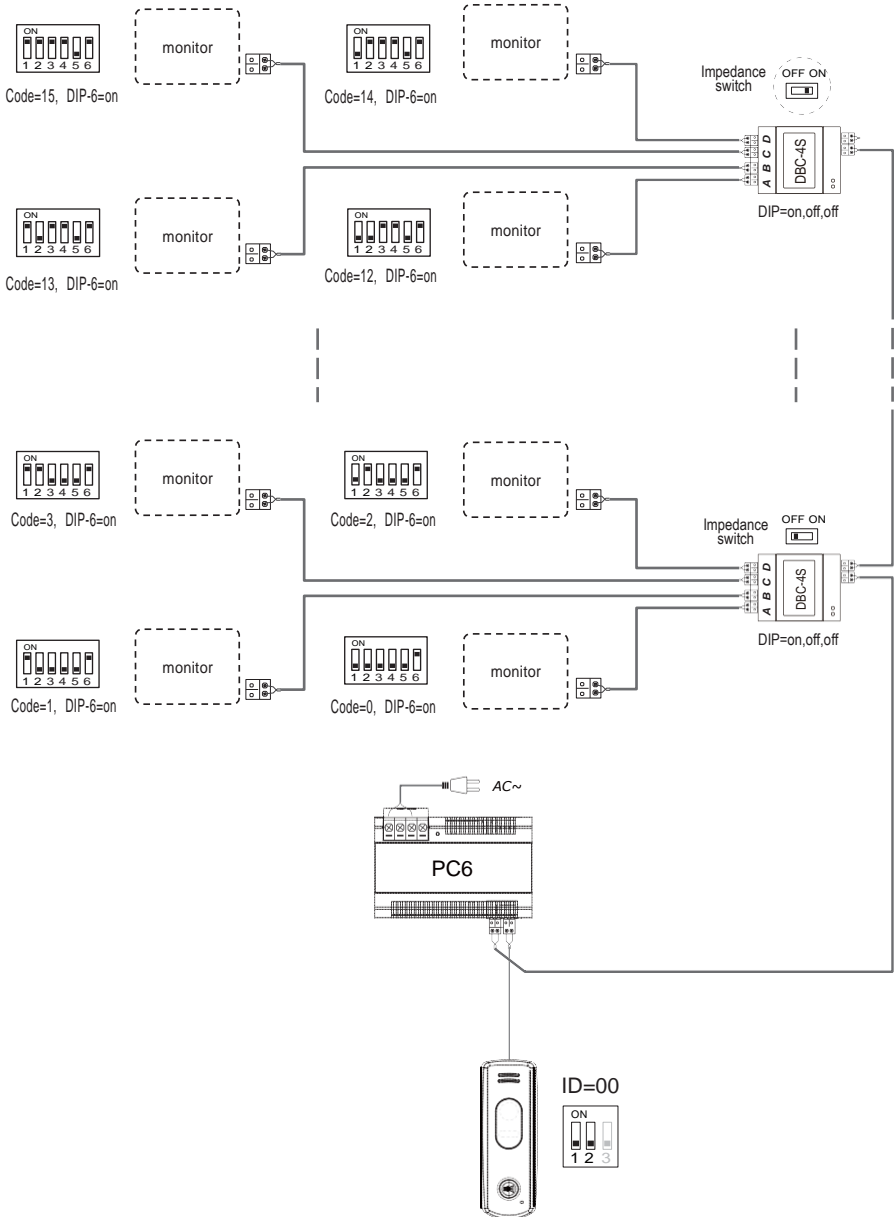

With DPV-D246 wiring mode

The audio door station DT595A can be extended an additional CCTV camera to be a video door station. For more details about the camera, please refer to DPV-D246 user instructions.

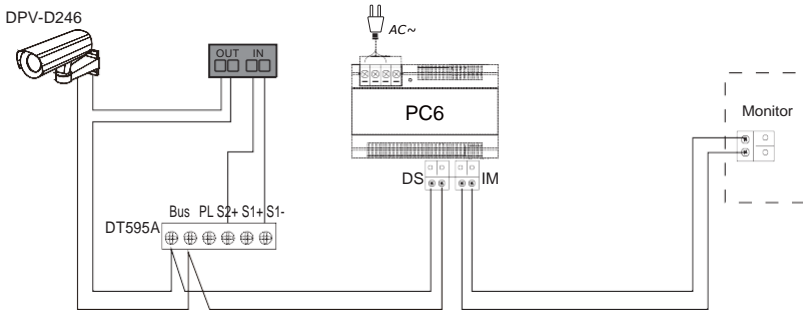

Electric Lock Connection

Door Lock Controlled with Internal Power

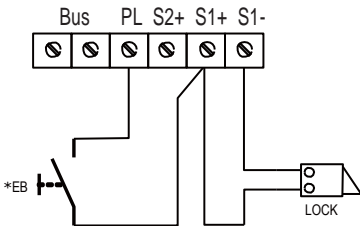
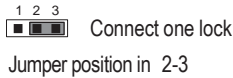

Note:

1. Electronic lock of Power-on-to-unlock type should be used.
2. The door lock is limited to 12V, and holding current must be less than 250mA.
3. The door lock control is not timed from Exit Button(EB).
4. The Unlock Mode Parameter of Monitor must be set to 0 (by default).

Door Lock Controlled with Dry Contact

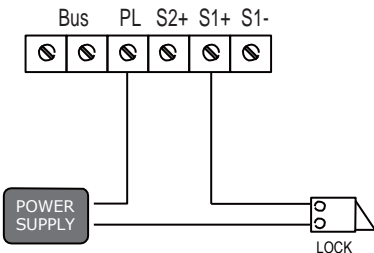
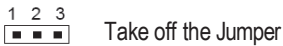

Note:

1. The external power supply must be used according to the lock.
 2. The jumper must be taken off before connecting.
 3. Setup the Unlock Mode of Monitor for different lock types.
- * Power-on-to-unlock type:Unlock Mode=0 (by default)
 * Power-off-to-unlock type:Unlock Mode=1



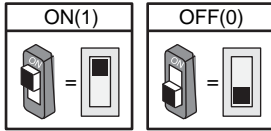

DIP Switch Setting

The DIP switch is designed to set the code for door station and monitor, there are two states for each DIP switch, please refer to the following sketch map.



Door station DIP setting

Total 3 bits can be configured, bit-1 and bit-2 are used to assign ID code for door station, bit-3 is used to match the video impedance. The switches can be modified either before or after installation.

Bit state	Description
	ID = 0(00), set to the first door station
	ID = 1(10), set to the second door station
	ID = 2(01), set to the third door station
	ID = 3(11), set to the fourth door station

















Note: if the video impedance need to match, please set the bit-3 on.

Indoor monitor DIP setting

There are 6 bits in total. The DIP switches are used to configure the user code for Monitors.

Bit-6 is an video impedance match switch, which have to be set to ON if match the impedance, otherwise set to OFF.

Bit-1~Bit-5 are used to set user code, to DT595A door station, the user code should set to 0~15. Please refer to the following settings:

Bit state	User code	Bit state	User code	Bit state	User code
	code=0		code=6		code=11
	code=1		code=7		code=12
	code=2		code=8		code=13
	code=3		code=9		code=14
	code=4		code=10		code=15
	code=5				

Specification

- Power Supply: DC 24V
- Power Consumption: Standby 60mA; Working status 200mA
- Lock Power Supply: 12Vdc, 300mA(Internal Power)
- Working Temperature: -10°C ~ +45°C
- Wiring: 2 wires, non-polarity
- Dimension: 137(H)x49(W)x28(D)mm

Precautions

- Please clean the unit with soft cotton cloth, don't use the organic impregnant or chemical clean agent. If necessary, please use a little pure water or dilute soap water to clean the dust.
- The unit is weather resistant. However do not spray high pressure water on access control keypad directly. Excessive moisture may cause problems with the unit.
- You must use the right adaptor which is supplied by the manufacture or approved by the manufacture.
- Pay attention to the high voltage inside the products, please refer service only to a trained and qualified professional.

Cable Requirements

The maximum distance of the wiring is limited in the D2 system. Using different cables may also affect the maximum distance which the system can reach.

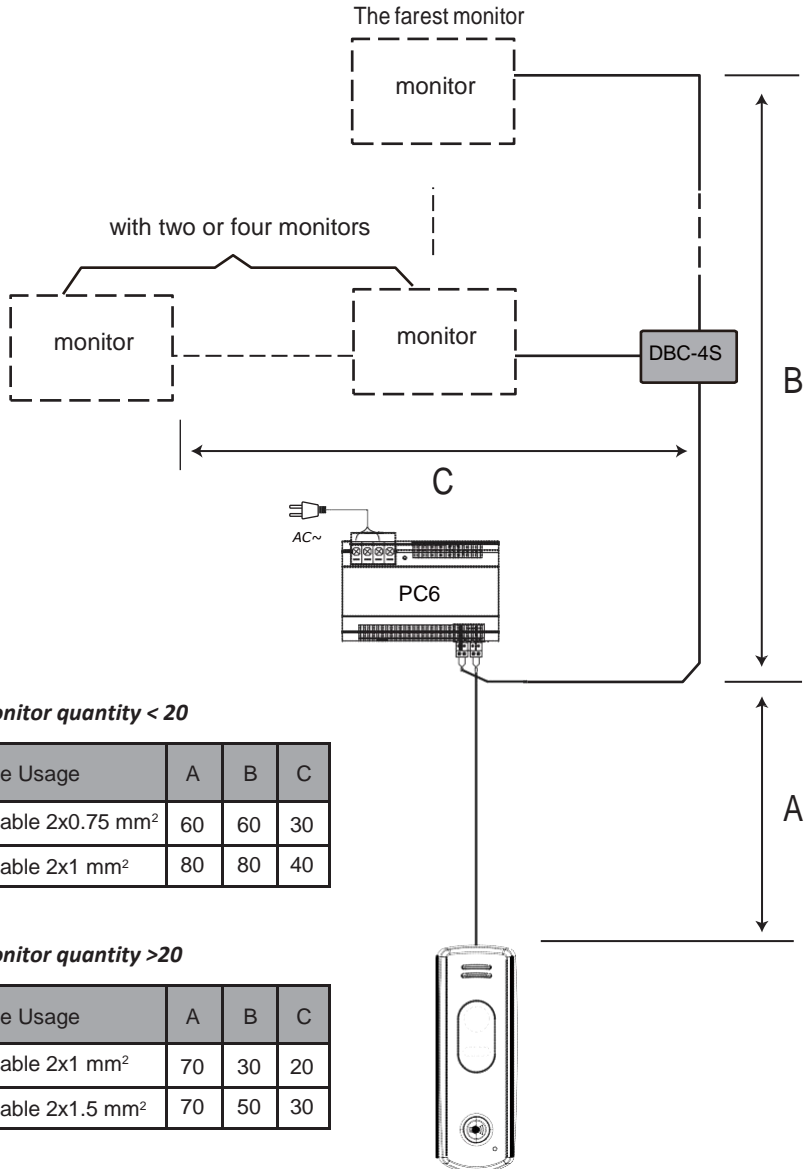

When Monitor quantity < 20

Cable Usage	A	B	C
Twisted cable 2x0.75 mm ²	60	60	30
Twisted cable 2x1 mm ²	80	80	40

When Monitor quantity >20

Cable Usage	A	B	C
Twisted cable 2x1 mm ²	70	30	20
Twisted cable 2x1.5 mm ²	70	50	30

Note: If the monitor has been specified the distance, refer to the parameter.

