

DPM-D241

User's manual

2 WIRE INTERCOM SYSTEM

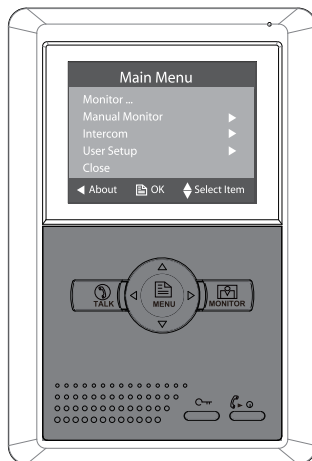

1. Parts and Functions

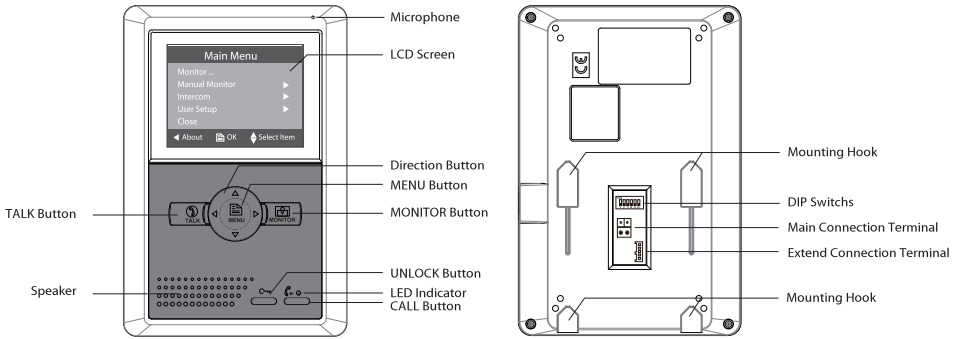

2. Monitor Mounting

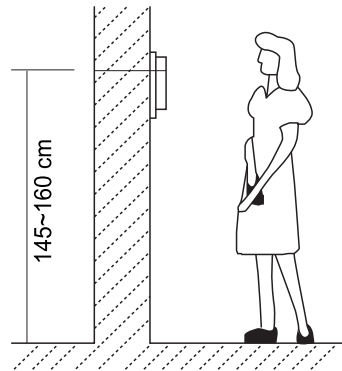
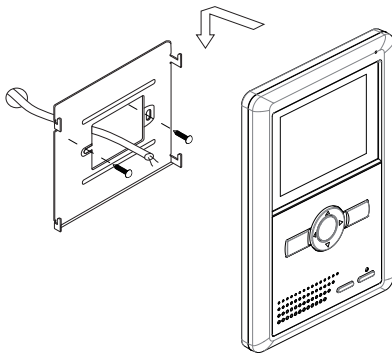

1. Use the screws to fix the Mounting Bracket on the mounting box.(fitting accesories includes a Bracket (Two pieces of 4X25 screws are needed for fastening the Mounting Bracket), Special 2 wire cables to connect with Monitor)
2. Wire the system correctly(see the later connection chapter) then hang the Monitor on the Mounting Bracket firmly.

3. Main Menu

1. Press **MENU** Button in standby mode, the date/time page will be showed. (the date/time page will be closed in 1 minute if no operation)
2. Press **MENU** Button again, main menu page will be showed.

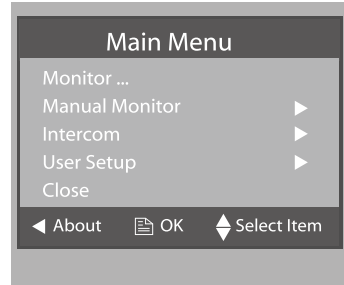
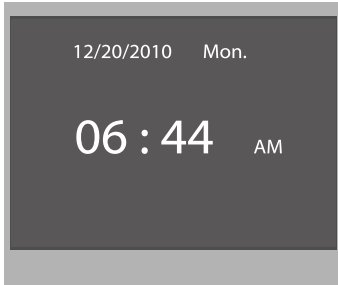

4. Basic Door Release Operation

1. Press **CALL** button on outdoor station, the Monitor rings, at the same time, the screen displays the visitor image.
2. Press **TALK** Button on monitor, you can communicate hands free with the visitor for 90 seconds. After finishing communication, press "TALK" button again to end the communication. If nobody answers the phone, the screen will be turned off automatically after 30 seconds.
3. During talking state, Press **UNLOCK** Button to open the door for the visitor.
4. When the monitor is in standby mode, press **MONITOR** Button (or select **Monitor ...** item on main menu page), The screen can display the view of outside. If multi door stations are installed, select **Manual Monitor** item to enter camera switch mode. Select **Camera 1 ...** item, the screen will display the image from the first door camera. Similarly. Select **Camera 2 ...** item to choose the second one. Select **Camera 3 ...** item to choose the third one. Select **Camera 4 ...** item to choose the fourth one. (Press "MONITOR" button again to end monitoring.)



5. Intercom Function

When the monitor is in standby mode, press **CALL** Button to enter Intercom Function page(or select **Intercom** item on main menu page). Use ▲ / ▼ Button to move upward / downward to select the item you want, press MENU Button to enter.

1. **Intercom Call:** User in one apartment can call other apartments in the system. the namelist will be created automatically by the system. Selete a name on the screen then press **MENU** button or **CALL** Button to dial.(Note:1. Press "MENU or CALL " button again to redial. 2. Press "TALK" button to cancel the call. 3.The DIP switches code of each monitor must set different.)
2. **Inner Call:** If multi Monitors are installed in the same apartment, select Inner Call, all the other Monitors will ring at the same time, whichever Monitor answers the call, conversation is started.and the other monitors will stop ringing at the same time. (note:the DIP switches setting of all monitors must be same.)
3. **Direct Dial Guard unit:** A Monitor can be assigned as Guard Unit Monitor; when the Guard Unit Monitor answers the call, conversation with the guard person is started..

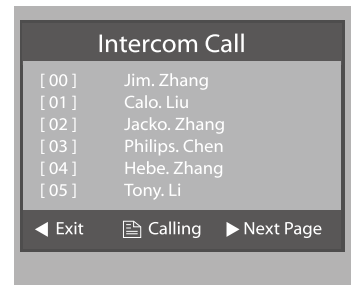

6. Basic Setup Instructions

Ring Tone Settings

Select **User Setup** item on main menu page to enter setup page.Select **Door Station Call Tone, Inercom Call Tone** or **DoorBell Tone** item, There are 12 pieces ring tones can be selected.use ▼ / ▲ Button to select last/next ring tone, press MENU button to save and exit.

Door Station Call Tone:set the ring tone calling from outdoor station.

Intercom Tone:set the ring tone calling from other apartments.

DoorBell tone:set the ring tone calling from door bell.

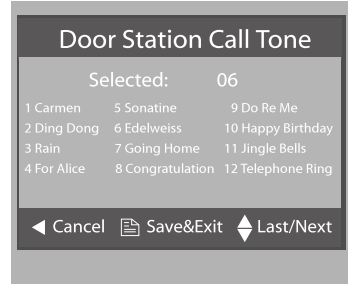
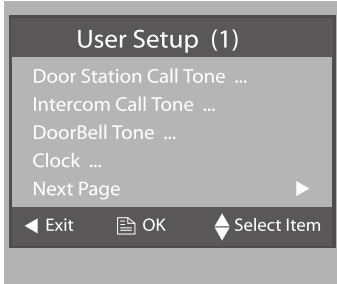

7. Date and Time Setting

Select **User Setup** item on main menu page to enter setup page,then use ▲ / ▼ button to select *Clock...* item. Input date and time by pressing ▲ / ▼ Button to increase / decrease the value; use ◀ / ▶ Button to select last/next digital. After finish, press MENU Button to confirm and return last page.



8. Monitor Time settig

Select **Manual Monitor** item on main menu page, then select *Monitor Time Set...* item. Use ▲ / ▼ Button to increase / decrease the value; After finish, press MENU Button to confirm and return last page.

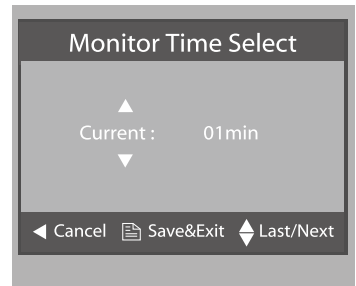

9. Restore to Default

Select **User Setup** item on main menu page to enter setup page, then select Next Page item and press MENU button to enter User Setup 2 page, select Restore to default item and press MENU button, a message will be asked to confirm the restore operation. Press Menu button again, All settings will be restored to default. (Note that the restore to default operation will not change the time setting and the datas.)

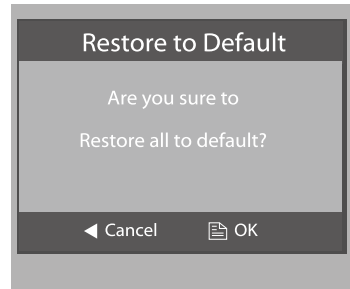
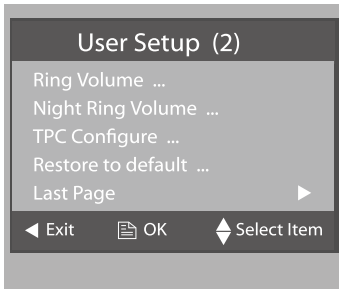

10. Unlock Parameter Setting

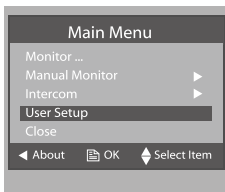

1. Select User Setup item on main menu page.

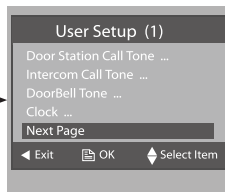

2. Select Next Page item to enter next page.

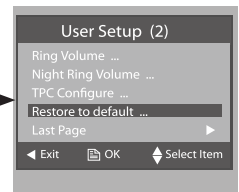

3. Select Restore to default item.

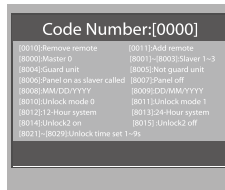

5. Input 4 digits number according to the following information. Use ▲ /▼ button to increase/decrease the value, use ◀ / ▶ button to select the digit.

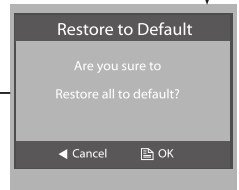

4. Press UNLOCK button and hold for 2 s.

Note:

1. 8015 is set the unlock2 off, you can only release one lock. 8014 is used to set the unlock2 on, when 2 locks are installed, this item must set on. you can release two locks. at this mode, press UNLOCK button, two unlock icons will be showed. Use ▲ / ▼ button to select the item you want, and press UNLOCK or MENU button to release the corresponding door, select ↶ item to exit.

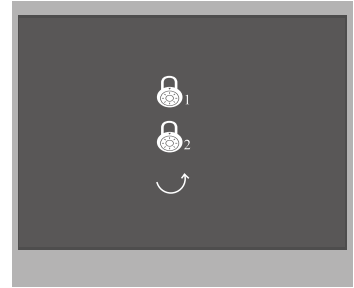

2. Restore to default operation will not change the parameters setting.

11. Screen and Volume Adjustment

During monitoring or talking, press MENU Button, the *ADJUST MENU* will be displayed.

Use ▲ / ▼ Button to select the adjustment item; use ◀ / ▶ Button to decrease / increase the value.

1. The first item is Scene mode selection: Total 4 screen modes can be selected in sequence: *Normal*, *User*, *Soft* and *Bright*. Whenever you modify *Brightness* or *colour*, *Scene* item will be set to *User* mode automatically.

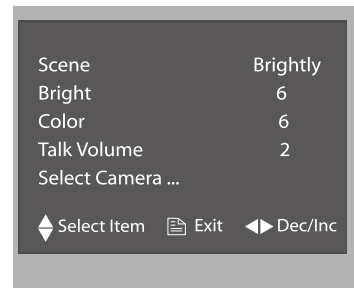

2. The *Brightness* and *Colour* item is for the image quality setting, adjust the value to get the best image you like.

3. The *Ring Volume* and *Talk Volume* items are ring tone and talking volume adjustment.

4. Note that all the modifications will be done immediately after the operation. Press "MENU" button to quit the adjust page.

12. Specification

- Power supply for indoor monitor: DC 24V
- Power consumption: Standby 0.5W; Working status 5W
- Monitor screen: 4 Inch color LCD
- Display Resolutions: 320(R, G, B) x 240 pixels
- Video signal: 1Vp-p, 75Ω, CCIR standard
- Wiring: 2 wires, non-polarity
- Dimension: 199(H) × 135(W) × 23(D)mm

The design and specifications can be changed without notice to the user. Right to interpret and copyright of this manual are preserved.