

2 WIRE INTERCOM SYSTEM

USER MANUAL

DPM-D271T

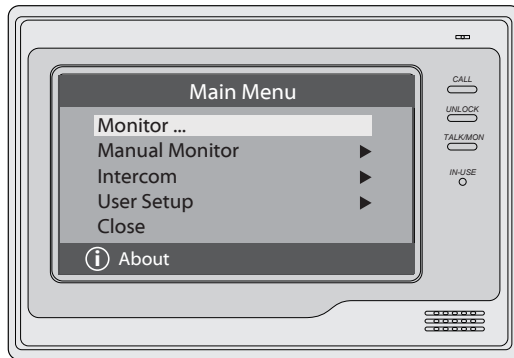

1. Parts and Functions

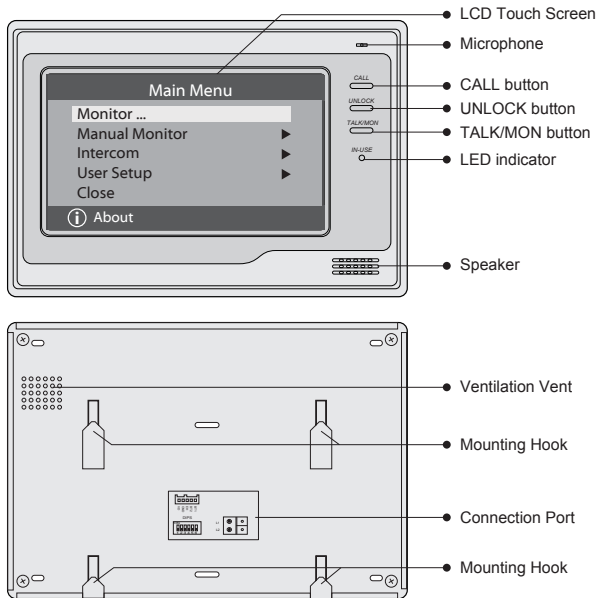

Key functions

LCD screen	Display the visitors' image
LED Indicator	Show the working status of monitor
Unlock button	Press to release the door
Call button	Press to activate intercom function
Talk/Mon button	Press to communicate hands free with visitor Press to view the outdoor condition in standby mode
Microphone	Receive voice from the user
Mounting hook	Use to hang up the monitor
Connection port	Bus terminal
Speaker	Send out voice from the visitor

2. Monitor Mounting

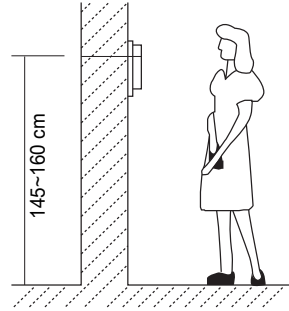
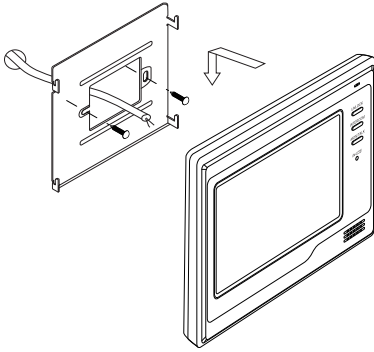



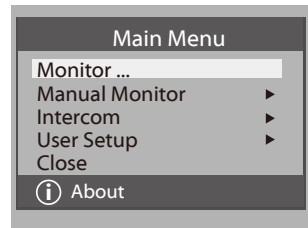
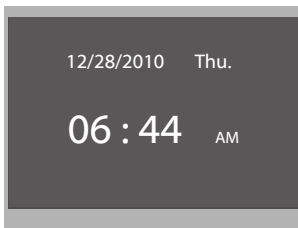

1. Use the screws to fix the Mounting Bracket on the mounting box.(fitting accesories includes a Bracket (Two pieces of 4X25 screws are needed for fastening the Mounting Bracket), Special 2 wire cables to connect with Monitor)
2. Wire the system correctly(see the later connection chapter) then hang the Monitor on the Mounting Bracket firmly.

3. Main Menu

1. Touch the screen anywhere on monitor in standby mode, the date/time page will be showed. (the date/time page will be closed in 1 minute if no operation)
2. Touch the screen again, main menu page will be showed as follows.



4. Basic Door Release Operation

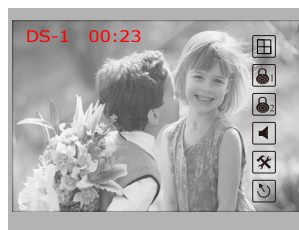

1. Press **CALL** button on outdoor station, the Monitor rings, at the same time, the screen displays the visitor image.
2. Press **TALK/MON** Button on monitor or touch  icon on screen, you can communicate hands free with the visitor for 90 seconds. After finishing communication, press **TALK/MON** button again or touch  icon to end the communication. If nobody answers the phone, the screen will be turned off automatically after 30 seconds.
3. During talking state, Press **UNLOCK** Button or touch  or  icon to open the corresponding door for the visitor.
4. When the monitor is in standby mode, press **TALK/MON** Button (or touch **Monitor ...** item on main menu page), The screen can display the view of outside. If multi door stations are installed, touch  icon to get into the camera switch mode (or direct touch **Manual Monitor** item on main menu page). You can touch camera 1/2/3/4 to monitor the door station or CCTV camera you want. See the following diagrams. (Press **TALK/MON** button again to end monitoring.)

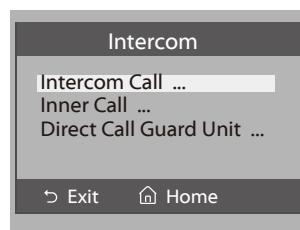

5. Intercom Function

When the monitor is in standby mode, press **CALL** Button to enter Intercom Function page (or direct touch **Intercom** item on main menu page).





1. **Intercom Call:** User in one apartment can call other apartments in the system. the namelist will be created automatically by the system. Touch a name you want on the screen, then touch  icon or press **CALL** Button on monitor to dial.(Note:1. touch  icon or press CALL button again to redial. 2. Press TALK/MON button to cancel the call. 3.The DIP switches code of each monitor must set different.)
2. **Inner Call:** If multi Monitors are installed in the same apartment, select Inner Call, all the other Monitors will ring at the same time, whichever Monitor answers the call, conversation is started.and the other monitors will stop ringing at the same time.(note:the DIP switches setting of all monitors must be same.)
3. **Direct Dial Guard unit:** A Monitor can be assigned as Guard Unit Monitor; when the Guard Unit Monitor answers the call, conversation with the guard person is started..



6. Basic Setup Instructions

Ring Tone Settings

Touch **User Setup** item on main menu page to enter setup page.Touch **Door Station Call Tone, Inercom Call Tone** or **DoorBell Tone** item, There are 12 pieces ring tones can be selected.touch a ring tone you want, then touch  icon to save and exit.(touch  icon to cancel the setting and return last page, touch  icon to get into main menu page)

Door Station Call Tone:set the ring tone calling from outdoor station.

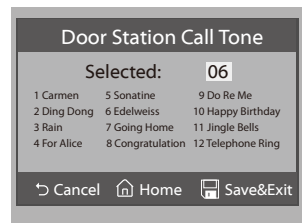
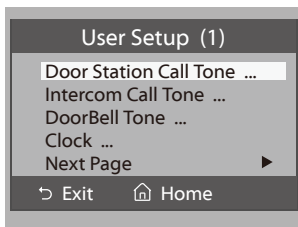

Intercom Tone:set the ring tone calling from other apartments.

DoorBell tone:set the ring tone calling from door bell.



Ring Volume and Night Ring Volume Setting

You can set a ring volume for day time and night time individually, 6:00 AM~18:00 PM is the day time and 18:00 PM~6:00 AM is the night time by default,if you don't want to be disturbed at night,you can set the night ring volume to 0.

Touch **User Setup** item on main menu page to enter setup page,then touch **Next Page** item to enter User Setup 2 page, select **Ring Volume Setting** or **Night Ring Volume** item. then touch ▲ / ▼ icon to increase / decrease the value; After finish, touch  icon to save and exit.(touch ↶ icon to cancel the setting and return last page, touch  icon to get into main menu page)

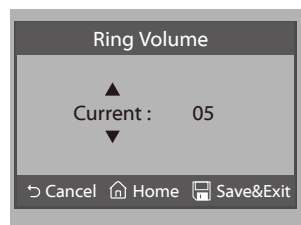
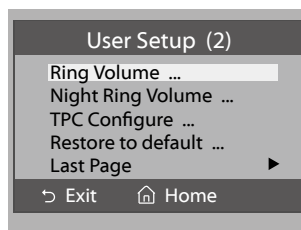

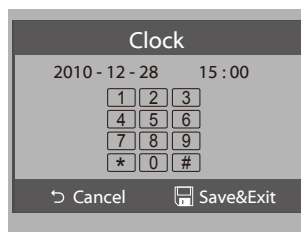

7. Date and Time Setting

Touch **User Setup** item on main menu page to enter setup page, touch **Clock...** item. a digital keypad will be showed on screen, input date and time by touching the digital keypad,use * icon to move the location. After finish, touch  icon to save and exit.(touch ↶ icon to cancel the setting and return last page.)



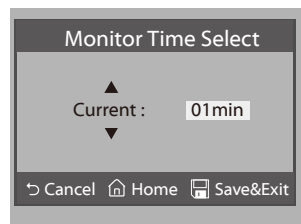

8. Monitor Time settig

Touch **Manual Monitor** item on main menu page to get into camera switch mode, select **Monitor Time Set...** item. touch ▲ / ▼ icon to increase / decrease the value; After finish, touch  icon to save and exit.(touch ↶ icon to cancel the setting and return last page, touch  icon to get into main menu page)



9. Restore to Default

Touch **User Setup** item on main menu page to enter setup page, then touch Next Page item to enter User Setup 2 page, touch **Restore to default** item, a message will be asked to confirm the restore operation. If touch  icon, All settings will be restored to default, if you don't want to restore, touch  icon to cancel the operation. (Note that the restore to default operation will not change the time setting and the datas.)

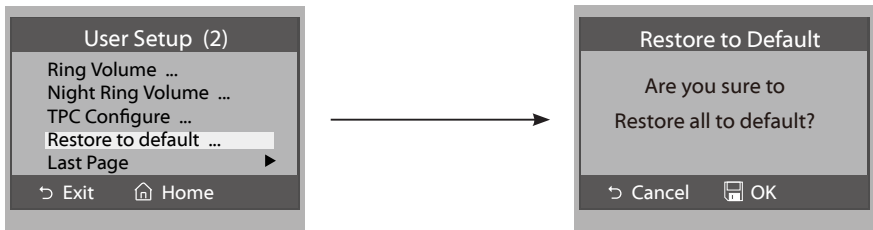

10. Monitor Parameter Setting

How to enter the installation setting page



1. Touch  About item on main menu page.

2. Touch the screen anywhere and hold for 2s.

3. A digital keypad will be showed.

How to set the monitor as a Guard Monitor

A Monitor can be assigned as Guard Unit Monitor; when the Guard Unit Monitor answers the call, conversation with the guard person is started..

The code number of 8004 is used to set the monitor as a guard unit monitor and 8005 is used to cancel this function.

How to set the slave monitor address

Maximum 4 monitors can be connected in one apartment, one master monitor together with 3 slave monitors, so you should set the address correctly. (note: must have one monitor to be set as master monitor)

The code of 8000 is used to set the master monitor.

The code of 8001 is used to set the first slave monitor.

The code of 8002 is used to set the second slave monitor.

The code of 8003 is used to set the third slave monitor.

Note: touch * button to cancel the input, touch # to save the settings.

.How to set date and time format

The system offers two methods of date and time.

The code number of 8008 is used to set the date format as month/date/year

The code number of 8009 is used to set the date format as date/month/year

The code number of 8012 is used to set the time format as 12 hour system

The code number of 8013 is used to set the time format as 24 hour system

How to set the monitor panel on

In default mode, when receive a calling, the master and slave monitors will ring at the same time, and just the master monitor can display the image while the slave monitors can not. But the settings can be changed, you can set the master monitor and all the slave monitors to panel on at the same time when receiving a call, just input the code number of 8006 on each slave monitor.

Press call button
on door station



When receiving calling, all monitors can display the image at the same time



Master monitor



#1st slave monitor



#2nd slave monitor



#3rd slave monitor

How to set the unlock parameter

Unlock mode:

There are two unlock modes: 1.power-on- to-unlock type:unlock mode=0(by default)
2.power-off-to-unlock:unlock mode=1.

The code number of 8010 is used to set the unlock mode to 0

The code number of 8011 is used to set the unlock mode to 1

Unlock time:

The unlock time can be changed by yourself at any time.it can be set from 1 to 9 seconds.

The code number from 8021 to 8029 are used to set the unlock time to 1~ 9 seconds.

How to set the menu language

The monitor can support multi languages and it is so simple and fast, just input the corresponding language code on monitor.The language code number are as follows:

8101: English	8107: Portuguese	8113: Russian
8102: French	8108: S-Chinese	8114: Slovakia
8103: Spanish	8109: T-Chinese	8115: Hungray
8104: Italian	8110: Greek	8116: Czech
8105: German	8111: Turkish	
8106: Dutch	8112: Polish	

Note:the monitor can only support 4 types of languages.English,French,Spanish and German are default.But you can customize any 4 languages by yourself.The language which is unavailable will be set to English in default.

11. Screen and Volume Adjustment

During monitoring or talking, touch  icon, the **ADJUST MENU** will be displayed. Touch and select the adjustment item you want; touch ◀ / ▶ icon to decrease / increase the value.

1. The first item is Scene mode selection: Total 4 screen modes can be selected in sequence: **Normal**, **User**, **Soft** and **Bright**. Whenever you modify **Brightness** or **colour**, **Scene** item will be set to **User** mode automatically.
2. The **Brightness** and **Colour** item is for the image quality setting, adjust the value to get the best image you like.
3. The **Ratio** item is for screen display adjustment, you can set to 16:9 or 4:3.
4. The **Talk Volume** item is for talking volume adjustment.
5. Note that all the modifications will be performed immediately after the operation. Touch ↶ icon to exit the adjust page.

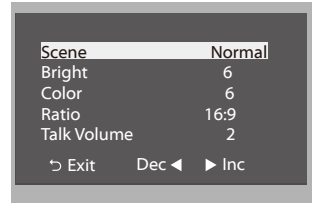

12. Specification

- Power supply for indoor monitor: DC 24V
- Power consumption: Standby 1.5W; Working status 10W
- Monitor screen: 7 Inch digital color LCD
- Display Resolutions: 800*3(R, G, B) x 480 pixels
- Video signal: 1Vp-p, 75Ω, CCIR standard
- Wiring: 2 wires, non-polarity
- Dimension: 155(H) × 225(W) × 28(D)mm