



IVS-170B

Net digital video server



User's Guide

Index

CHAPTER 1 INTRODUCTION.....	4
1.1 IVS-170B FUNCTIONS AND FEATURES	4
1.2 COMMON APPLICATION	5
CHAPTER 2 INSTALLATION.....	6
2.1 HARDWARE INSTALLATION	6
2.1.1 <i>Installation steps</i>	6
2.1.2 <i>Installation notice</i>	6
2.2 PRODUCT DEMONSTRATION	7
2.3 THE PIN DEFINITION OF PHYSICS INTERFACES	8
2.3.1 <i>PIN definition of RS-232 serial interface</i>	8
2.3.2 <i>PIN definition of RS485 serial interface</i>	10
2.3.3 <i>PIN definition of Ethernet interface</i>	10
CHAPTER 3 VIDEO SERVER SETUP	12
3.1 PARAMETER SETUP THROUGH RS-232 SERIAL PORT	12
3.1.1 <i>Hyper Terminal Setup</i>	12
3.1.2 <i>Shell Commands Under Hyper Terminal</i>	15
3.2 PTZ CONTROL	17
3.3 CONFIGURE PARAMETERS THROUGH CLIENT-END SOFTWARE.....	18
3.3 CONFIGURE PARAMETERS THROUGH WEB INTERFACE.....	19
CHAPTER 4 UPGRADE FIRMWARE.....	20
4.1 USE SHELL COMMAND AND TFTP SERVER	20
4.2 USE CLIENT SOFTWARE TO UPGRADE FIRMWARE	24
CHAPTER 5 PPPOE DIALUP OPERATION	26
5.1 USING PPPoE TO ESTABLISH CONNECTION	26
5.2 CLIENT ACCESS DVS WHEN USING PPPoE	27
CHAPTER 6 FREQUENT ASK QUESTIONS.....	29
APPENDIX A IVS-170B SPECIFICATIONS.....	30
APPENDIX B GOOD LIST.....	31

Thanks for purchase the products of our company. If you have any request or questions, please contact us immediately.

This manual is applicable for IVS-170B Video Server.

This manual may contain some technically incorrect places or printing errors. This manual will be updated on a regular basis without additional specific notice. The updates will be added into the new version of this manual. We will readily improve or update the products or procedures described in the manual.

Chapter 1 Introduction

IVS-170B video server adopts embedded Linux operation system (RTOS) and TI Davinci processor, which is completely independent of PC platform and, efficiently improves system performance. Firmware is burned in FLASH, makes the system more steady and reliable.

IVS-170B is one channel network digital video server. It can also be used as IP module. As IP module, it can be combined into camera and speed dome to build IP camera and IP dome. IP module can be customization design. It can compress the video signal and audio signal simultaneously into H.264 compression stream and transmit the compression stream through network. It can support real-time video and audio preview, support stream protocol (RTP/RTCP, RTSP), IE browser and bi-directional voice communication, etc.

Notes:

IVS-170B: 1 channels video input and 1 channels audio input. It can support 4CIF resolution real time (25FPS for PAL or 30FPS for NTSC).

1.1 IVS-170B functions and features

- **Basic Function:**
 1. High speed & high compression ratio of H.264 video hardware real-time compression;
 2. Multiple security level leads to high system safety;
 3. Support one RS-485 interface that can be used to control pan-tilt-zoom and translucent channel input;
- **Compression Function**
 1. Support 1 Channel of video (PAL/NTSC) signal, and can be real-time hardware compressed in 25F/S (PAL) or 30F/S (NTSC) CIF resolutions independently. Video is compressed using H.264 standard, and it **supports not only variable bit rate but also variable frame rate**. When choosing video image quality, you can also limit the bit rate of the compression code.
 2. Support OSD the position of the date and time can be adjusted, date and time can be added automatically.
 3. Support LOGO, the position of it can be anywhere in the video image.
- **Network Function**
 1. Support one 10M/100M Ethernet compatible interface;
 2. Support TCP/IP protocol; Parameter setting, real-time video & audio previewing, status examination, alarm through network and store the compression bit rate through network.
 3. Support pan-tilt-zoom control such as the turn of PTZ, iris and focus;
 4. Support remote upgrading and maintenance;
 5. RS-485 interfaces support transparent transmission mode, and remote hosts can control

serial devices through it;

1.2 Common application

Network digital surveillance, such as ATM machine, factory and the bank etc.;

Remote monitoring service for prison, nursery and school;

Intelligent gate system (dynamic record the people in and out);

Intelligent building and community;

Uncared-for system of electric power station or telecom base station;

Outdoor equipment monitoring;

Bridge, tunnel and cross road-monitoring system;

Pipeline, warehouse monitoring;

24 hour monitoring of traffic;

Remote monitoring of forest, water and river, etc.

Chapter 2 Installation

2.1 Hardware installation

2.1.1 Installation steps

1. Open packing case, and check the integrity;
2. Take out things needed in installation;
3. Connect cables needed (video signal input cable, audio signal input cable, RS485 cable and cable for LAN);
4. Take out stabilizer power supply and power on.

2.1.2 Installation notice

Please read the following notice carefully. If you have any question, please contact us.

Notice:

1. After Opening the packing box, please check carefully to confirm that the goods in it are consistent with list;
2. Please read user's manual carefully before installation;
3. Please power-off all related equipments before installation;
4. Please check the voltage of power supply to avoid voltage mismatch;
5. Installation environmental: Do not use it under humidity and high temperature; to keep ventilation to vent freely, avoid to be walled up; to keep them horizontally, avoid to set up in the vibration surroundings.

2.2 Product demonstration



2.3 The pin definition of physics interfaces

2.3.1 PIN definition of RS-232 serial interface

The DVS has one RS232 standard serial interface, with RJ-45 connector. Its pin definition is as follows ('I' means input, and 'O' means output):

Table 2.1 Pin definition of RS232 serial port

Pin No	Neme	I/O	Explanation
1	DCD	I	Carrier Detect
2	RxD	I	Receive
3	TxD	O	Transmit
4	CTS	I	Clear send
5	RTS	O	Request to send
6	DTR	O	Data Terminal Ready
7	GND		GND
8			

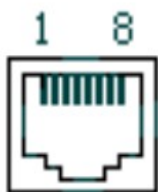
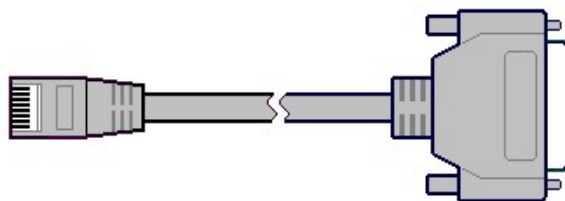
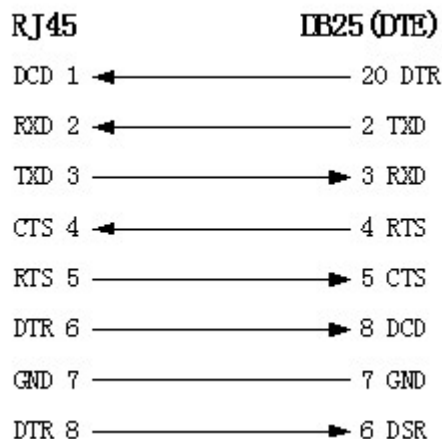

Fig 2.1 RJ-45

(1) When the RS232 interface of the DVS connects with the DTE equipment, one end of the cable is the 8-pin RJ45 connector (to DVS) and the other of the cable is the DB25 female connector (to DTE). Below is the description of the internal connection between RJ45 and DB25.





(2) 25-pin to 9-pin converter's internal connection is like this:

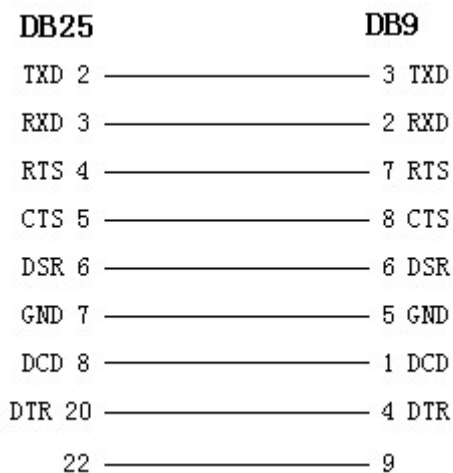

(3) If you don't want to use 25-pin to 9-pin converter to connect DVS and DTE through RS232 interface, you must use RJ45-DB9 cable. Its internal connection description is:

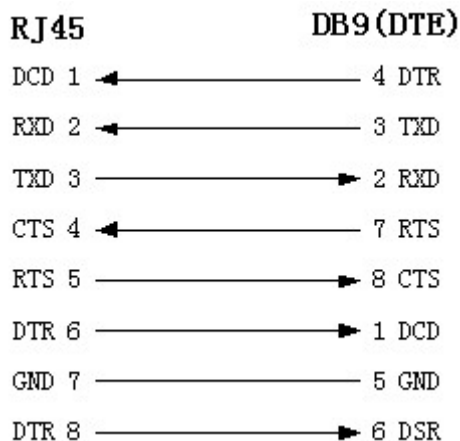

(4) When the RS232 interface of the DVS connects with the DCE (such as MODEM), one end of the cable is the 8-pin RJ45 connector and

the other is the DB25 male connector. Below is the description of the internal connection between RJ45 and DB25:

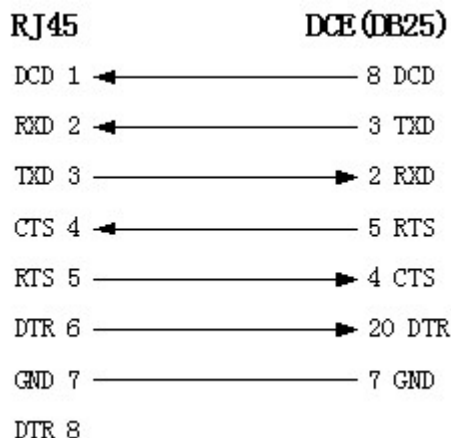

2.3.2 PIN definition of RS485 serial interface

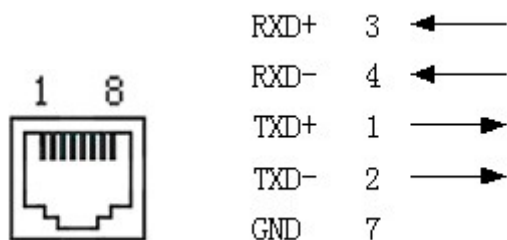

2.3.3 PIN definition of Ethernet interface

(1) PIN definition of the direct network cable connecting DVS and HUB:

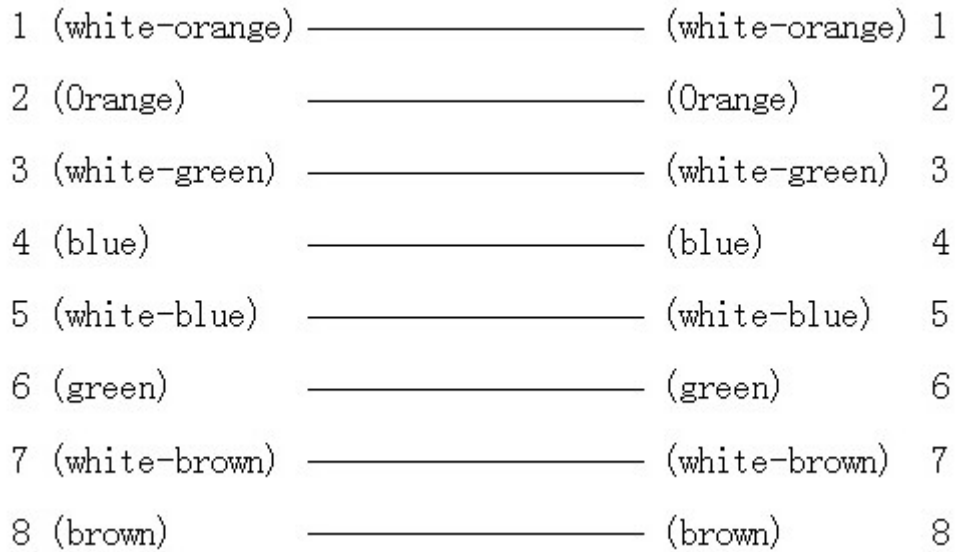

(2) PIN definition of the cross network cable connecting DVS and host PC:

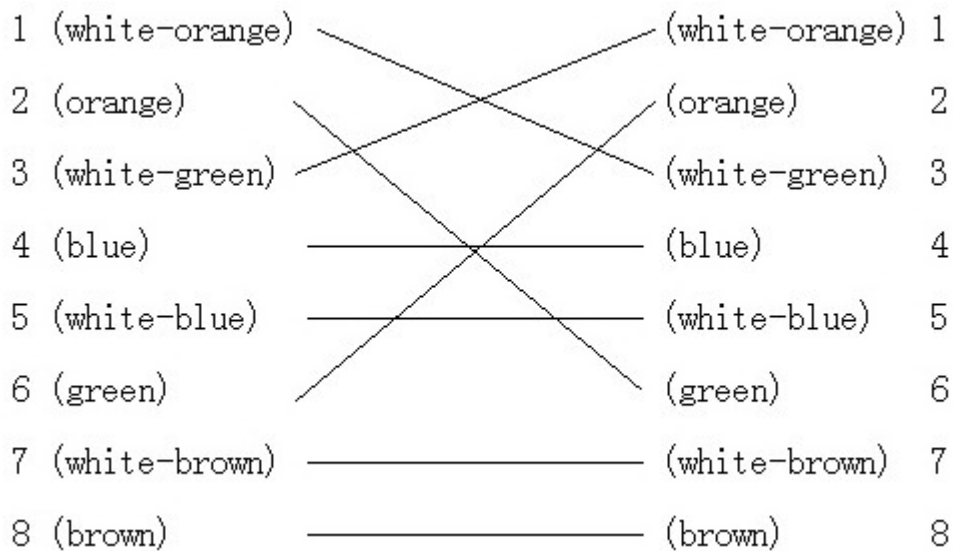

Chapter 3 Video Server Setup

There are four kinds of methods to configure the parameters of video server.

1. Through Hyper Terminal (connect DVS with the PC through RE-232 serial ports)
2. Through TELNET (connect DVS with PC through network)
3. Through client-end application software (connect DVS with PC through network)
4. Through web interface in Internet Explorer (connect DVS with PC through network)

3.1 Parameter Setup through RS-232 serial port

Mainly set up IP parameters of the video server through serial port. The defaulted IP address is 192.0.0.62.

Under the case that the IP address is unknown; the Hyper Terminal (need to connect the serial ports) can only be adopted to configure IP address and other parameters. Under the case that IP address is known, TELNET can be adopted to configure IP address and other parameters, and can also modify the IP address by using client-end software.

3.1.1 Hyper Terminal Setup

Please direct connect the RS-232 serial port of PC with the RS-232 serial port of video server before configuration (there are RJ45 head and DB9 line in the packing carton)

How to establish the connection with the super terminal connection?

Step one: Enter into Hyper Terminal. Click “Start” → “Programs” → “Accessories” → “Communications” → “Hyper Terminal” in Windows system, and the dialogue box below will appear (Fig. 3.1.1):

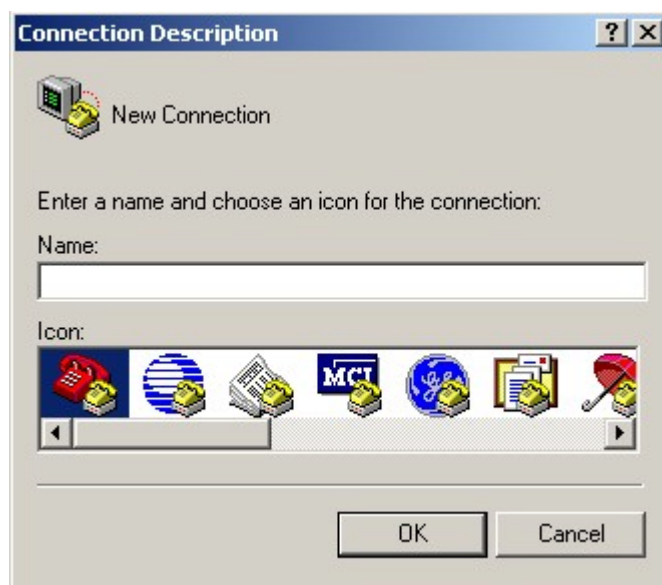

Fig. 3.1.1 newly establish a connection and define the name and icon

Step2: To name the connection name and to define the icon. Input a name (e.g. aa), select a icon, press “OK”, the dialogue box like Fig. 3.1.2 appears.



Fig. 3.1.2 select communication port

Step 3”: to select the communication port. Select “com1” communication port in Fig3.1.2, press “OK”, the dialogue box as Fig. 3.1.3 will appear.

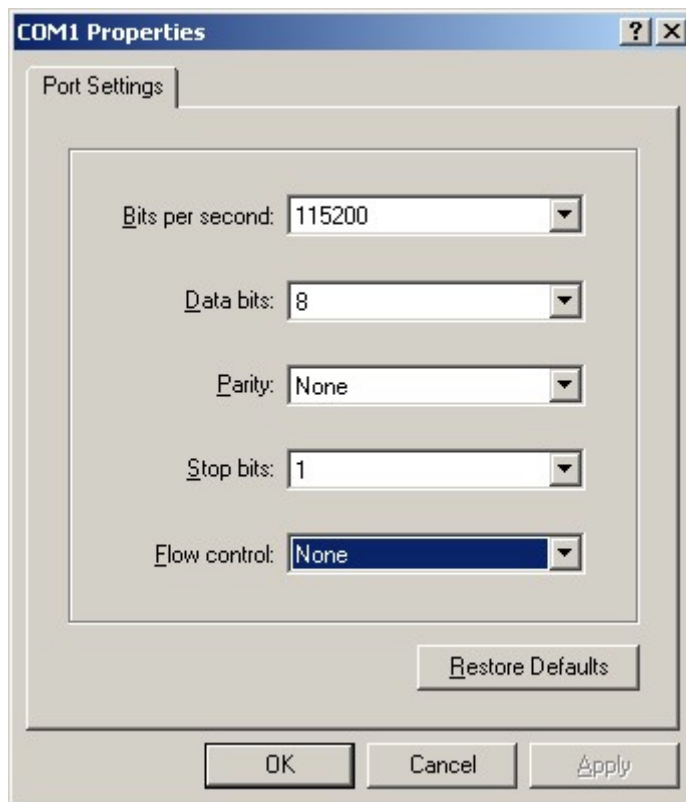

Fig. 3.1.3 Serial ports parameter setup

Step 4: Serial port parameters setup. Set the serial port parameters as the following setup: Bits per second: 115200, Data bits: 8, Parity: None, Stop bits: 1, Flow control: None. Press “OK” after

finish, the Hyper Terminal interface like Fig. 3.1.4 will appear

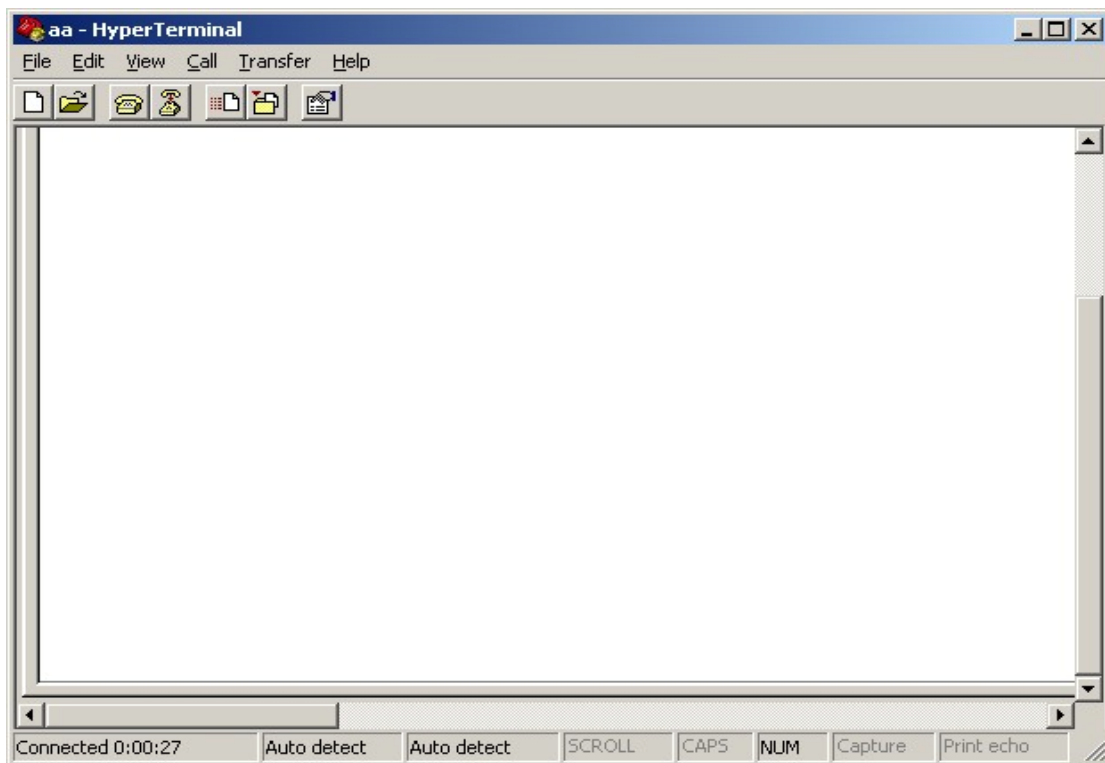

Fig. 3.1.4 Hyper Terminal Interface

Step 5: To close the window, the Fig. 3.1.5 will appear. Select “Yes” and Fig. 3.1.5 will appear. Select “Yes” again to have the Fig. 3.1.6

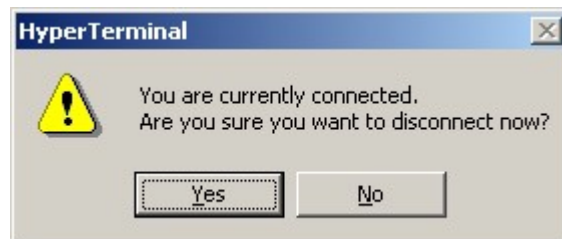

Fig. 3.1.5 to disconnect

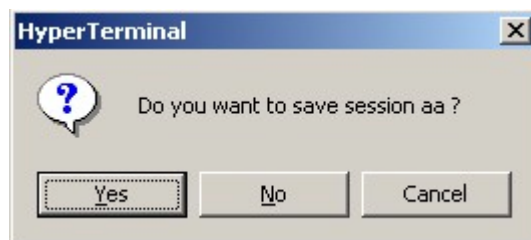

Fig. 3.1.6 save Hyper Terminal session

Step 6: Save the Hyper Terminal session for using next time. After saving, it will new establish a “Hyper Terminal” item in the program group “Start” → “Programs” → “Accessories” → “Communications” → “Hyper Terminal” and it includes all “Connection” name for all Hyper Terminal. Here you have see a icon named “aa.ht”.

3.1.2 Shell Commands Under Hyper Terminal

Please use the DTE cable and the DB9/DB25 converter to connect PC with DVS RS-232 port.

Step 1: Enter into the Hyper Terminal. Click “ Start”→ “Programs”→ “Accessories”→ “Communications”→ “Hyper Terminal”→ “aa.ht”, the Hyper Terminal interface in Fig. 3.1.4 will appear.

Step 2: Press “Enter” in Hyper Terminal, the prompt “—>” appear, as in Fig. 3.1.7. Under this prompt the following operation commands to accomplish the setup of the parameters.

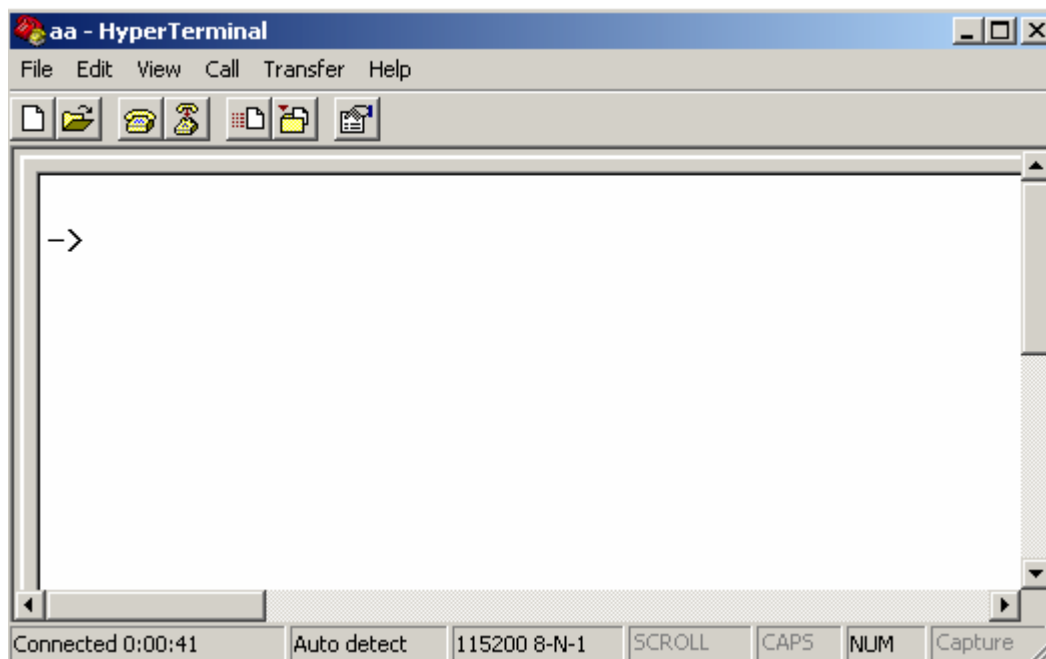

Fig. 3.1.7 Hyper Terminal command prompt

Input help, the supported configuration commands can be checked up, as in Fig. 3.1.8.



Fig. 3.1.8 to check command

The following is the introduction of getIp, setIp commands.

getIp

Function: to get the fixed IP, subnet mask, gateway, command port, IP address of PPPoE dialup (the IP address of PPPoE will be 0.0.0.0 if there is no dialup or dialup is not successful).

Parameter: none.

Grammar format: Enter after input the command

Explanation: Please pay attention whether the inputting letters are capital or low case.

```

aa - HyperTerminal
File Edit View Call Transfer Help
-> help
help      : Print this List.
exit      : Logout of telnet.
getIp     : Get device's IP address.
setIp     : Set device's IP address. e.g. setIp 192.168.1.10:255.255.255.0

setPort   : Set device's command port.
setGateway : Set device's gateway.
-> getIp
IP address : 192.0.1.62
Subnet mask : 255.255.248.0
Command port : 8000
-> _
Connected 0:02:46 Auto detect 115200 8-N-1 SCROLL CAPS NUM Capture Print echo

```

Fig. 3.1.9 to get parameters of IP, PPPoE

setIp

Function: to set the IP, subnet mask and gateway of the device

Parameter: IP address, subnet mask, gateway

Grammar format: setIp IP: mask

Explanation: Please pay attention whether the inputting letters are capital or low case. And separate the parameters by colons.

```

aa - HyperTerminal
File Edit View Call Transfer Help
->
-> help
help      : Print this List.
exit      : Logout of telnet.
getIp     : Get device's IP address.
setIp     : Set device's IP address. e.g. setIp 192.168.1.10:255.255.255.0

setPort   : Set device's command port.
setGateway : Set device's gateway.
-> setIp 192.0.1.62:255.255.248.0
-> _
Connected 0:00:42 Auto detect 115200 8-N-1 SCROLL CAPS NUM Capture Print echo

```

Fig. 3.1.10 to set IP

3.2 PTZ control

Step1: Connect IVS-170B RS-485 interface with PTZ. Please refer to RS-485 pin definition. DVS just uses Pin1 (TX+) and Pin2 (TX-) to send PTZ control command.

Step2: You can use remote client software to setup PTZ protocol.

In client software remote setup dialog box, select “Serial Para” tab button. You can select DVS PTZ parameters in the corresponding dialog box.

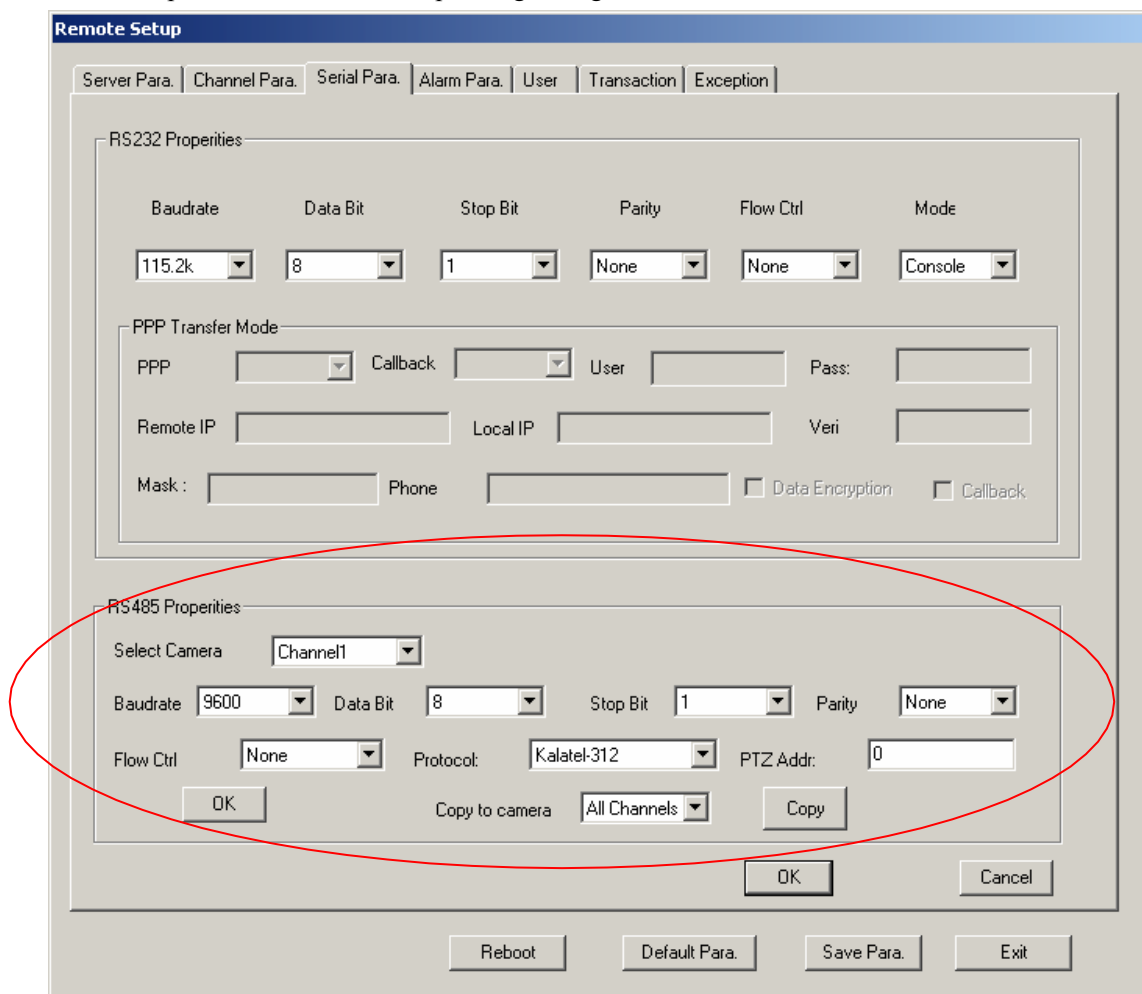

Please refer to client software user manual for detail information.

3.3 Configure parameters through client-end software

Before the configuration, please make sure that the PC and the video server has been established the network connection, you can confirm using PING command. Please refer to the user manual of DVRDVS client software for detail information.

The screenshot shows the 'Remote Config' window with the following configuration details:

Remote Config			
Server Para.	Channel Para.	Serial Para.	Alarm Para. User
Server Parameters			
DVRDVS Name	Embedded Net DVS	HDD Number	0
DEV ID	88	DNS IP Address	0.0.0.0
IP Address	192.0.1.62	Multicast IP	0.0.0.0
Port Number	8000	Gateway IP	0.0.0.0
MASK IP	255.255.248.0	NFS IP	0.0.0.0
Net Interface	10M/100M AUTO	NFS Directory	
MAC Address	00:40:30:40:b0:50	Remote Host IP	0.0.0.0
Channel Number	4	Remote Host	0
Firmware Version	V1.4 build 050915	PPPoE	NO
Hardware Version	0x50000000	PPPoE User	
Front Panel	0	PPPoE Password	
DSP Version	V3.7 build 050818	PPPoE IP	0.0.0.0
AlarmIn Number	4	Cycle Record	YES
AlarmOut Number	2	DVRDVS Type	DVS
		Http Port	80
Serial Number	DS6004HC0020050728AAWR000062848WCU		

Buttons: OK, Cancel, Save Para., Default Para., Check Sys Tim, Format Disk, Exit

3.4 Configure parameters through WEB interface

Before the configuration, please make sure that the PC and the video server has been established the network connection, you can confirm using PING command.

In Internet Explorer open IP address of your IVS. As login use user: "admin" and password: "12345"

Note: If u have problem with installing ActiveX control, you should set in Internet Explorer menu "Tools" → "Internet options" → "Security" → "Custom level". When you click on "Custom level" find "download unsigned activeX control" and set "Prompt" options. Now you can install ActiveX control and have a web access to DVS.

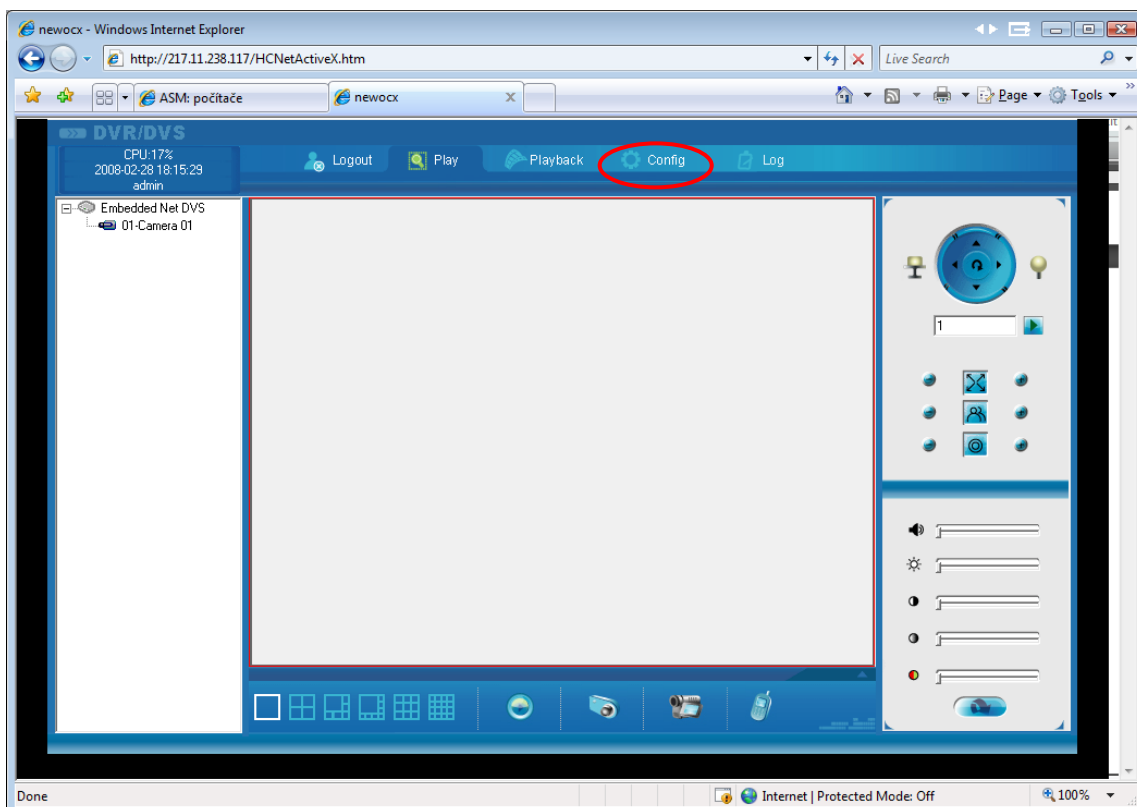

Click on "Config" on DVS web interface.

Remote parameters Config

DVSR Para. Chan Para. Serial Para. Alarm Para. User Transaction Other

DVSR parameters information

DVSR Name	Embedded Net DVS	Cycle Record	Yes
Device ID	88	Use Scale	UnUse
Channel Number	1	HDD Number	0
AlarmIn Number	1	AlarmOut Number	1
DVSR Type	DVS		
Serial Number	DS6101HFI-IP-A0020071220AAWR100040607WC		

DVSR net parameters information

NIC Type	10M/100M AUTO	MAC Address	00:40:36:36:3a:6f
DVSR IP	217 . 11 . 238 . 117	Port	8000
Subnet Mask	255 . 255 . 255 . 224	Gateway IP	217 . 11 . 238 . 97
DNS IP	0 . 0 . 0 . 0	Multicast IP	0 . 0 . 0 . 0
Manage Host IP	0 . 0 . 0 . 0	Manage Host Port	0
Use PPPoE	UnUse	PPPoE IP	0 . 0 . 0 . 0
PPPoE User		PPPoE Password	
NAS Host IP	0 . 0 . 0 . 0	NAS Directory	
HTTP Port	80		

DVSR version information

SoftwareVersion	V2.0 build 070703	HardwareVersion	0xd0d0000
DSP Version	V4.0 build 070628	FrontPanel Version	0

Restore Reboot Save Exit

Chapter 4 Upgrade Firmware

There are two methods to upgrade the DVS firmware. One is using shell commands to ask DVS to download firmware from TFTP server. The other is using PC client software.

4.1 Use Shell Command and TFTP Server

Step 1:

Before the update start you should do the follow steps:

1. Download the TFTP server from the internet, such as Cisco TFTP Server. Then put the firmware in the root directory of the Cisco TFTP Server.
2. Connect the device to the Router.
3. Please use DTE cable to connect device 232 port with COM port of the server PC.
4. Configure the Hyper Terminal. Steps as below.

Enter into start----all programs----accessories-----communications----hyper terminal. Click hyper terminal.

- 1) Input the name “xtendlan”. And do the step 1 again. Then enter into fig 4. select COM1 and click “OK” to enter into fig 5.



Fig 3



Fig 4

- 2) Modify the bits per second to ‘115200’. and modify the flow control to ‘None.’ Finally click “apply” and “ok” to enter into the hyper terminal main interface.

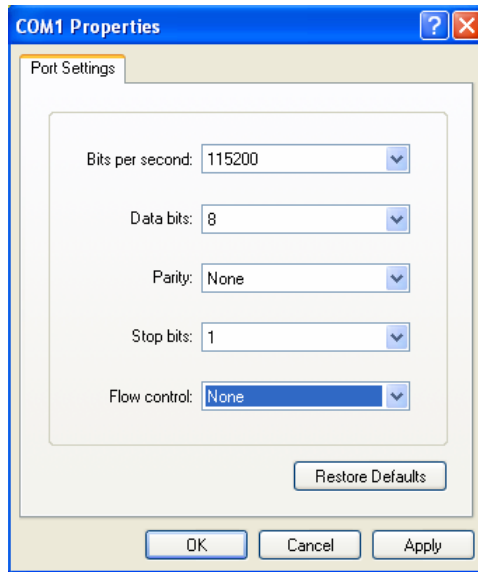

Fig 5

Step 2:

Then reboot the device and press any button in the pc keyboard again and again until the HIK # come out in the Hyper Terminal interface, show as fig 6. then input the “print” to check if the IP of the server and device is correct, also both of them should be in the same LAN. you can use the command

“set serverip” to modified the server ip

“set ipaddr” to modified the device ip

“set netmask” to modified the mask ip

Show as the fig 7.

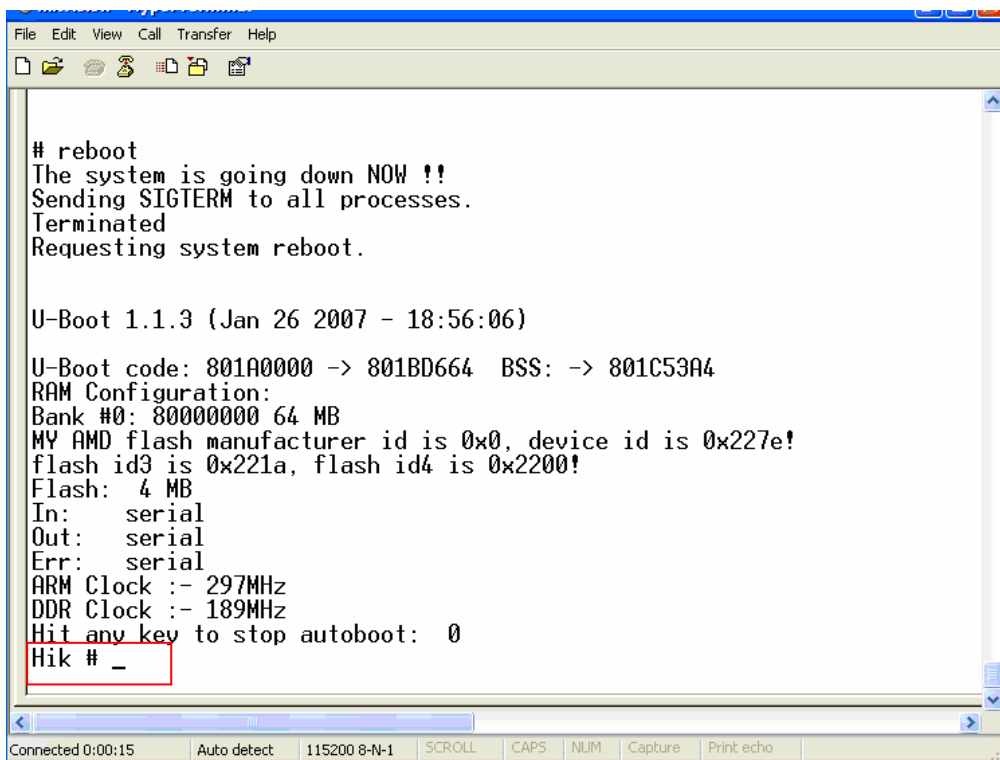

```
File Edit View Call Transfer Help
# reboot
The system is going down NOW !!
Sending SIGTERM to all processes.
Terminated
Requesting system reboot.

U-Boot 1.1.3 (Jan 26 2007 - 18:56:06)

U-Boot code: 801A0000 -> 801BD664 BSS: -> 801C53A4
RAM Configuration:
Bank #0: 80000000 64 MB
MY AMD flash manufacturer id is 0x0, device id is 0x227e!
flash id3 is 0x221a, flash id4 is 0x2200!
Flash: 4 MB
In: serial
Out: serial
Err: serial
ARM Clock :- 297MHz
DDR Clock :- 189MHz
Hit any key to stop autoboot: 0
Hik # _
```

Fig 6

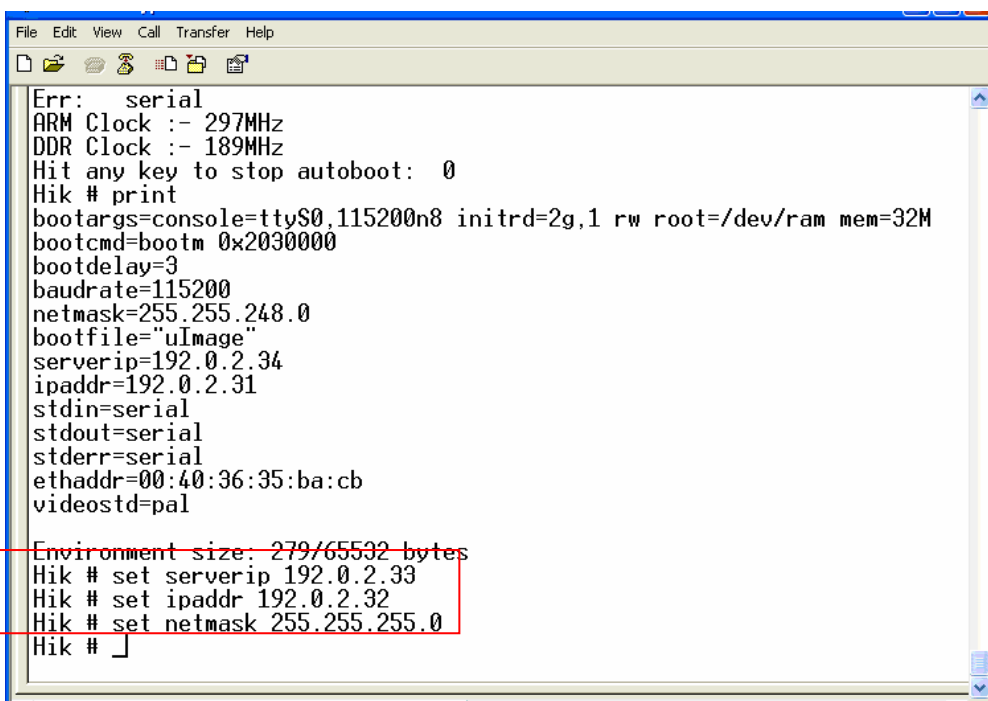

```
File Edit View Call Transfer Help
Err: serial
ARM Clock :- 297MHz
DDR Clock :- 189MHz
Hit any key to stop autoboot: 0
Hik # print
bootargs=console=ttyS0,115200n8 initrd=2g,1 rw root=/dev/ram mem=32M
bootcmd=bootm 0x2030000
bootdelay=3
baudrate=115200
netmask=255.255.248.0
bootfile="uImage"
serverip=192.0.2.34
ipaddr=192.0.2.31
stdin=serial
stdout=serial
stderr=serial
ethaddr=00:40:36:35:ba:cb
videostd=pal

Environment size: 279/65532 bytes
Hik # set serverip 192.0.2.33
Hik # set ipaddr 192.0.2.32
Hik # set netmask 255.255.255.0
Hik # _
```

Fig 7

Step 3:

Input the command “save” and press enter button. Show as fig 8.

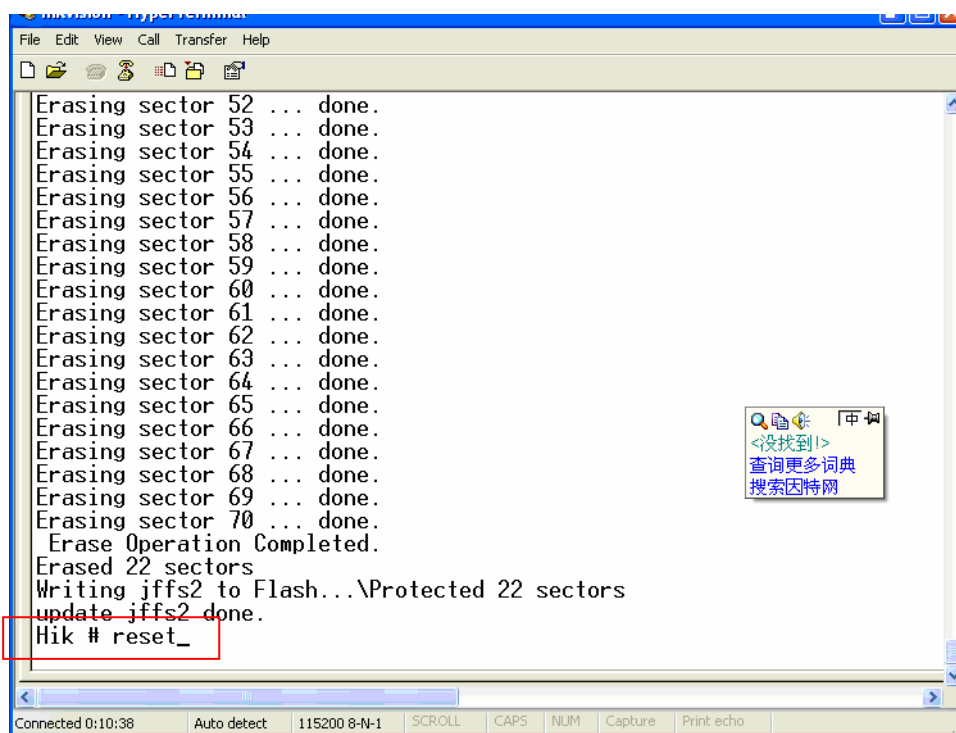
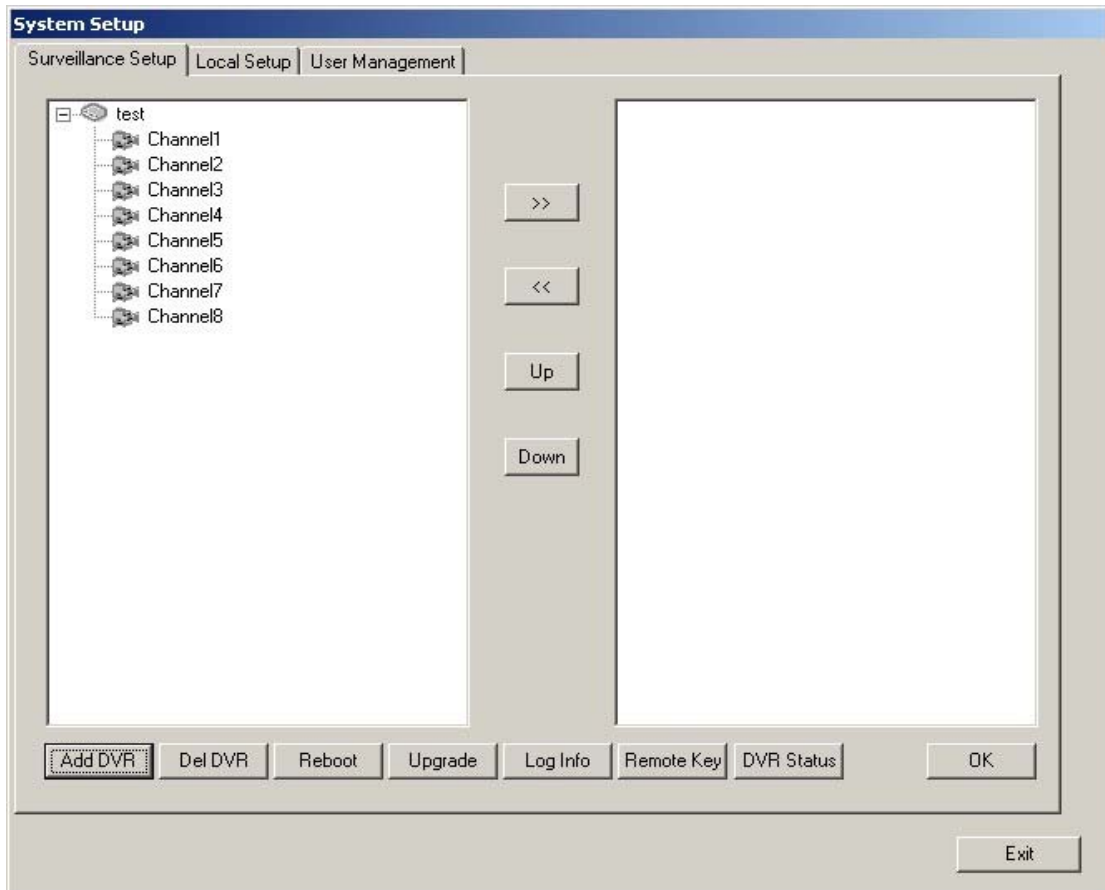

Fig 10

4.2 Use Client Software to upgrade firmware

In the system setup dialog of DVRDVS client software (refer to client software user manual), there is a button named “Upgrade”:



Select the DVRDVS, Click “Upgrade” button, the following dialog box will be appeared:

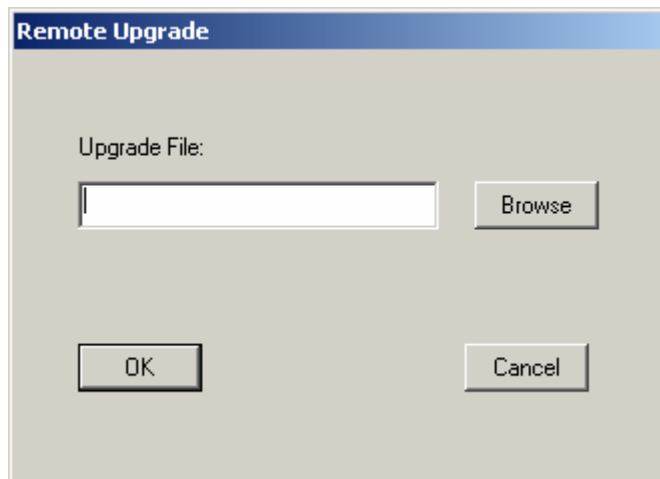

Fig.4.21 remote upgrading

Click “Browse” button and select the firmware file. Then click “Upgrade” button, to complete the upgrading process of the video server firmware.

Chapter 5 PPPoE dialup operation

IVS-170B video server supports remote access through network, through browser, through PPPoE or PPP dialup. Before using this function, please make sure that the software you used in your device support such functions or not.

5.1 Using PPPoE to establish connection

In the local LAN, use the client software remote setup the DVS parameters. The setup dialog is looked as following:

Server Parameters	
DVRDVS Name	Embedded Net DVS
DEV ID	88
IP Address	192.0.1.62
Port Number	8000
MASK IP	255.255.248.0
Net Interface	10M/100M AUTO
MAC Address	00:40:30:40:b0:50
Channel Number	4
Firmware Version	V1.3 build 050512
Hardware Version	0x50000000
Front Panel	0
DSP Version	V3.5 build 050223
AlarmIn Number	4
AlarmOut Number	2
Serial Number	DS6004HC0020050728AAWR000062848BWCU
HDD Number	0
DNS IP Address	0.0.0.0
Multicast IP	0.0.0.0
Gateway IP	0.0.0.0
NFS IP	0.0.0.0
NFS Directory	
Remote Host IP	0.0.0.0
Remote Host	0
PPPoE	NO
PPPoE User	
PPPoE Password	
PPPoE IP	0.0.0.0
Cycle Record	YES
DVRDVS	DVS

In the server parameters sub dialog, enable PPPoE function, input the correct PPPoE user name and PPPoE password. Click “OK” button and “Save Para.” button. The new server parameters will be saved into video server through network. Reboot the video server, the DVS will start to dialup the Internet. After success, the video server will get a dynamic WAN IP address.

Server Parameters	
DVRDVS Name	Embedded Net DVS
DEV ID	88
IP Address	192.0.0.64
Port Number	8000
MASK IP	255.255.255.0
Net Interface	10M/100M AUTO
MAC Address	00:40:30:40:b2:dd
Channel Number	4
Firmware Version	V1.3 build 050518
Hardware Version	0x50000120
Front Panel	0
DSP Version	V3.5 build 050223
AlarmIn Number	4
AlarmOut Number	2
Serial Number	DS6004HC0020050613AAWR000063501BWCU
HDD Number	0
DNS IP Address	220.184.114.48
Multicast IP	0.0.0.0
Gateway IP	0.0.0.0
NFS IP	0.0.0.0
NFS Directory	
Remote Host IP	0.0.0.0
Remote Host	0
PPPoE	YES
PPPoE User	hzhz88846467
PPPoE Password	*****
PPPoE IP	0.0.0.0
Cycle Record	YES
DVRDVS	DVS

[Explanation] please make sure that ADSL Modem is installed. If it is the first time to set PPPoE parameters, it needs to reboot video server to establish the connection.

5.2 Client access DVS when using PPPoE

There are two methods:

One is to access using the current WAN IP address of the video server.

When the video server is successful establish the network connection by using PPPoE mode, it will get the WAN IP address. You can use Hyper Terminal to get the WAN IP address, and access this IP address through client software.

The other is to access through domain analysis server. By using this mode, you need a PC with a fixed WAN IP address in the Internet, and there is the domain analysis server software running in this PC (actually this PC is the analysis server). We provide such demo DNS software and SDK.

In the server parameters of video server, there is an item named DNS. Please input the PC fixed WAN IP address here. When the video server is successfully connection with the internet by using PPPoE, it will get a dynamic WAN IP address, and send the name and current IP address to the analysis server. If the client-end software wants to access the video server, it'd first to

connect with the PC used as the analysis server, telling the analysis server which one video server he wants to access. The analysis server will search all the video servers have been registered, find out the server with the same name or same serial number, and tell the client-end the WAN IP address of the video server. After the client-end software get the current IP address, it can establish the network connection with the video server to get the video images directly.

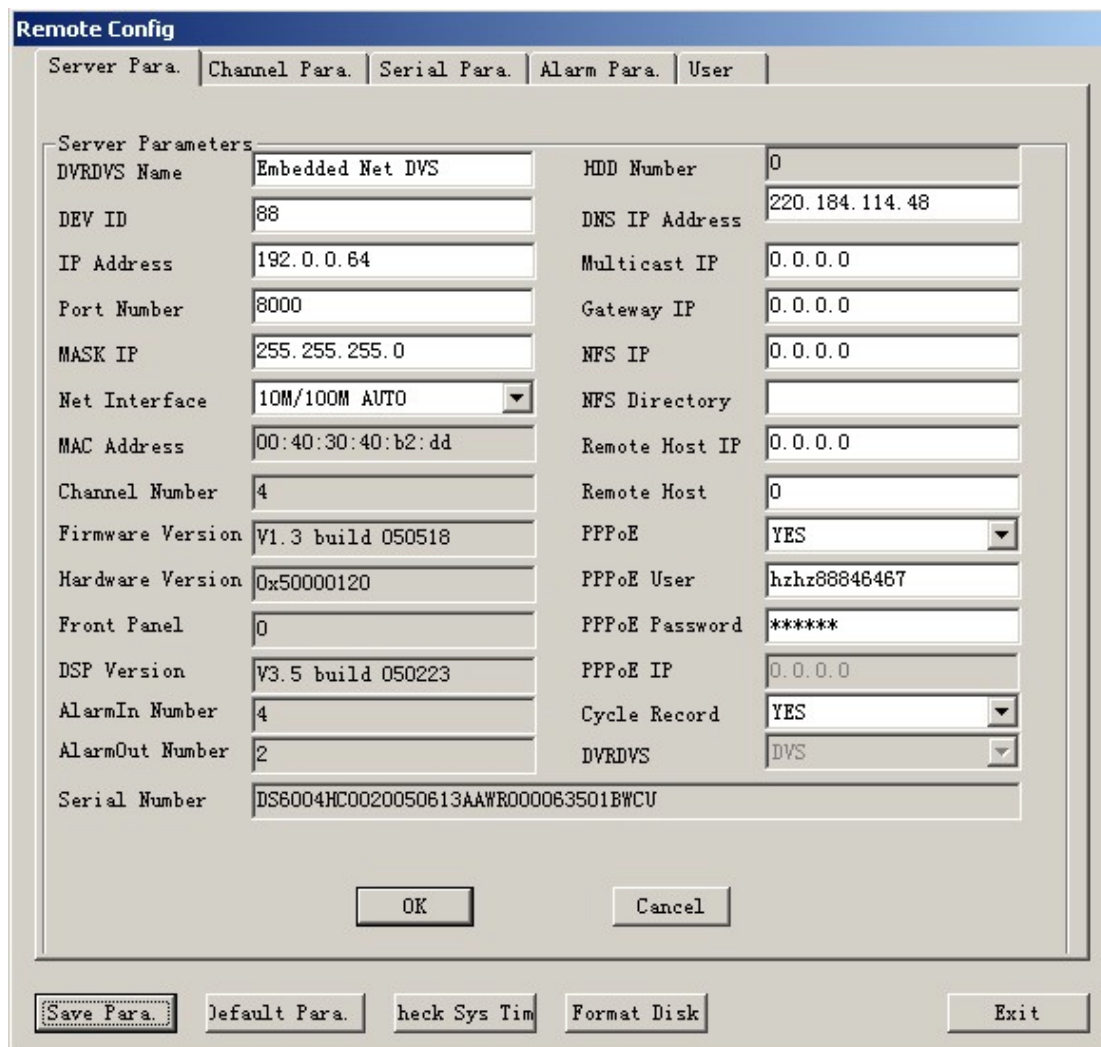

Here the fixed WAN IP address of PC is 220.184.114.48. We call it as DNS IP. In that the PC, a demo analysis server software named IPServer is run. It can get the video server information, including the dynamic WAN IP address of the video server.

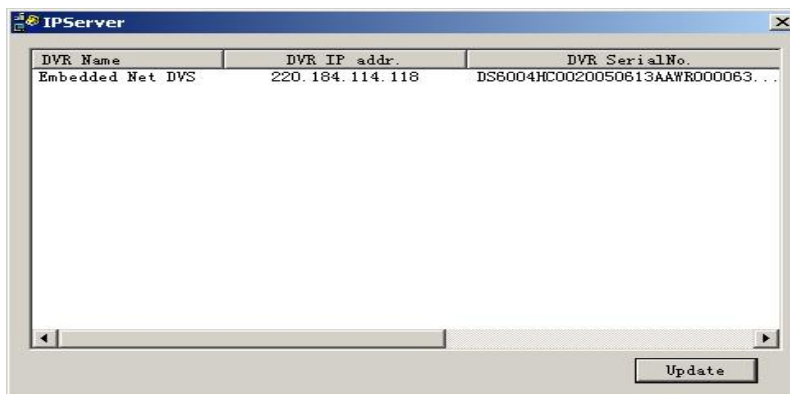

Chapter 6 Frequent ask questions

1, Failure to control PTZ

It is possible that the camera and equipment are not connected through RS485 port, or the wrong configuration of the decoder.

2, certain individual channel picture is un-normal

Please check whether the video cable is well connected with the camera and the Embedded DVS

3, Possible reasons which can cause the failure of upgrading

Failure of the network, IP address error in the FTP host computer, FTP service is not been booted by PC, the path to upgrade is incorrect, no permission (usually happened when to upgrade through client-end.)

If the above information cannot meet your demand, please not hesitate to contact the provider.

Appendix A IVS-170B Specifications

Video compression	H.264
Compress resolution	4CIF/DCIF/2CIF/CIF/QCIF
Video input	1-ch BNC (1.0Vp-p, 75Ω)
Frame rate	PAL: 25 FPS; NTSC: 30 FPS
Audio input	1-ch BNC (2.0Vp-p, 1kΩ)
Audio compression	OggVorbis, 16Kbps
Stream type	Video stream or Video&Audio stream
Bit rate	32kbps~2Mbps (Self definition)
Line input for voice talk	1-ch RCA (2.0Vp-p, 1KΩ)
Audio output	1-ch RCA (Linear Electrical Level, 600Ω)
Communication interface	1 RJ45 10M/100M UTP network port 1 RJ45 RS-232 port
PTZ control	RS-485 dry node (T+, T-)
External alarm input	1 input
Relay output	1 output
Power supply	DC +5V
Power consumption	Less than 3W
Working temperature	-10°C - +55°C
Working humidity	10%--90%
Size with enclosure	70mm*120mm*45mm

PAL: 176*144(QCIF), 352*288(CIF), 704*288(2CIF), 528*384(DCIF), 704*576(4CIF);

NTSC: 176*120(QCIF), 352*240(CIF), 704*240(2CIF), 528*320(DCIF), 704*480(4CIF).

Stabilizer power supplier: input AC 100-240V47-63Hz

Appendix B Good list

1. One piece of IVS-170B video server;
2. A CD contains client application;
3. One power supply voltage stabilizer
4. A 220V power cable;
5. A cable connecting RS232 with DTE;